

PRODUCT CATALOG



Implantech[®]

SEPTEMBER 2019

Superior Facial & Body Aesthetics

Designed by prominent surgeons, Implantech's facial implants provide the youthful, cosmetic and reconstructive solutions desired by your patients. Count on our comprehensive line of silicone and expanded polytetrafluoroethylene (ePTFE) facial implants for industry-leading innovation and effective, pleasing outcomes.

To enhance body areas, accept nothing less than our solid-silicone ContourFlex™ and PowerFlex™ products. Soft and supple, Implantech's gluteal, pectoral and calf implants provide shaped volume and smoothed edges for the most natural look and feel. Our expanded lineup now includes more styles, with smooth and textured options for all three body-contouring areas and super-soft gluteal and pectoral selections.

If no stock product is appropriate, tap into our patient-specific resources. We faithfully reproduce silicone implants either from CT scans with our 3D Accuscan® service or from a mold you make with one of our Moulage Kits. Or, carve your own from silicone blocks of different sizes, shapes and durometers.

For scar management, our Cimeosil® products are specifically formulated for the topical management of keloids and hypertrophic scars. Our Cimeosil Scar and Laser Gel also helps with any scarring or redness associated with laser surgery, dermabrasion and chemical peels. Made of stretchable, fabric-covered silicone gel, our Gelzone® Wraps combine compression healing, musculoskeletal support and scar management.

You can also depend on Implantech for sheeting and tubing. We offer sterile ePTFE and silicone sheeting for short term or long term applications and non-sterile, implant grade and health care grade silicone tubing.

Get the service, quality, innovation and choices you and your patients deserve. Welcome to Implantech!

Table of Contents

<i>Silicone Facial Implants</i>	<u>2</u>
Chin	<u>3</u>
Chin Sizing Guide	<u>7</u>
Mandibular Angle.....	<u>9</u>
Submalar	<u>11</u>
Midfacial.....	<u>12</u>
Tear Trough.....	<u>13</u>
Temporal	<u>14</u>
Nasal	<u>15</u>
<i>ePTFE Products</i>	<u>17</u>
Composite™ Facial Implants (ePTFE Coated)	<u>18</u>
ePTFE Facial Implants	<u>20</u>
ePTFE Sheeting	<u>22</u>
<i>Instrument-Related</i>	<u>23</u>
<i>Silicone Carving Blocks</i>	<u>24</u>
<i>Body-Contouring Implants</i>	<u>27</u>
Gluteal.....	<u>28</u>
Pectoral	<u>30</u>
Calf.....	<u>33</u>
<i>3D Accuscan Patient-Specific® Implants</i>	<u>34</u>
Patient-Specific Resources (3D Accuscan® and Moulage Kits)	<u>35</u>
<i>Silicone Sheeting & Tubing</i>	<u>36</u>
AlliedSil™ Silicone Sheeting (Non-Reinforced).....	<u>37</u>
AlliedSil™ Silicone Sheeting (Reinforced).....	<u>38</u>
AlliedSil™ Silicone Tubing.....	<u>39</u>
<i>Scar Management</i>	<u>40</u>
Cimeosil® Scar and Laser Gel	<u>41</u>
Cimeosil® Gel Sheeting.....	<u>42</u>
Gelzone® Wrap	<u>46</u>
<i>Orthopaedic Products</i>	<u>44</u>
WeL® Anti-Clog Suction Tubes.....	<u>45</u>
Gelzone® Suspension Sleeve	<u>45</u>
Gelzone® Wrap.....	<u>46</u>
<i>Ordering Information</i>	<u>48</u>

SILICONE FACIAL IMPLANTS



All Supplied Sterile

Crafted with the highest quality of implant grade silicone, our implants are ideal for augmenting chin, midfacial, mandibular, nasal and other facial areas.

Choose from over 35 styles and variations of facial implants for a long term, symmetric and pleasing look, including:

- Our core line of trusted, time-tested silicone implants
- Conform™ silicone implants with a grid-like backing that readily adapts to bony contours

Conform™ Extended Anatomical Chin

Evolution of all of the technology and design of our previous chin implants. Incorporates the patented Conform™ grid pattern to allow for easier implant insertion and to closely conform to underlying bony structure.

Cat. No.	Size	A	B	C	D	E	F
CEAC-S	Small	5.0	1.00	0.43	8.0	3.5	0.2
CEAC-M	Medium	5.6	1.20	0.50	10.0	4.2	0.3
CEAC-L	Large	6.2	1.35	0.60	10.0	4.5	0.3
CEAC-XL	X-Large	6.8	1.50	0.75	11.0	5.0	0.3
CEAG-SIZ-NS	Sizers	Complete Set					

Dimensions in centimeters

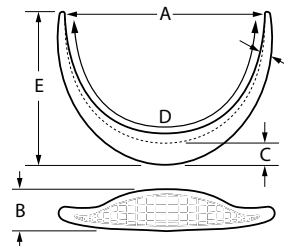
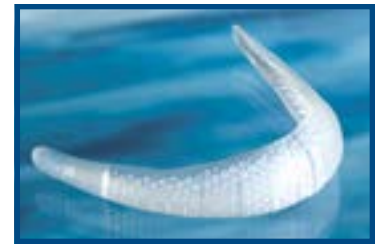

Extended Anatomical Chin

Full lateral arms blend into mandible. Can be used with Glasgold Wafer™ for additional anterior augmentation. ePTFE-Coated Extended Anatomical Chin available on page 18.

Cat. No.	Size	A	B	C	D	E	F
EAC-S	Small	5.5	1.0	0.45	9.0	3.7	0.2
EAC-M	Medium	5.6	1.2	0.50	9.5	4.2	0.4
EAC-L	Large	6.8	1.4	0.60	11.0	4.8	0.4
EAC-XL	X-Large	6.0	1.4	0.75	11.0	5.1	0.5
EAC-SIZ-NS	Sizers	Complete Set					

Dimensions in centimeters

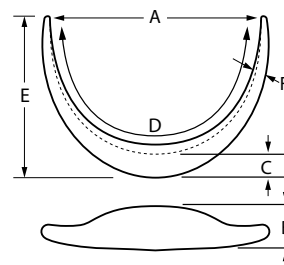

Terino Extended Anatomical™ Chin

Lateral arms are thinner and broader than Extended Anatomical Chin for less palpable edges. Profile is slightly squarer for a stronger jawline. Can be used with Glasgold Wafer™ for additional anterior augmentation.

Cat. No.	Size	A	B	C	D	E	F
TEAC-S	Small	5.7	1.0	0.38	11.0	4.8	0.3
TEAG-M	Medium	5.7	1.2	0.46	11.3	5.0	0.3
TEAG-L	Large	5.7	1.3	0.58	11.5	5.2	0.3
TEAG-XL	X-Large	5.7	1.4	0.64	11.5	5.2	0.4
TEAG-SIZ-NS	Sizers	Complete Set					

Dimensions in centimeters

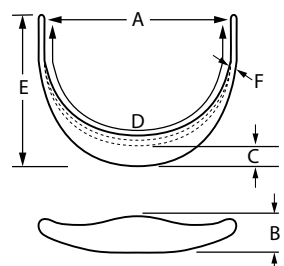

CHIN IMPLANTS

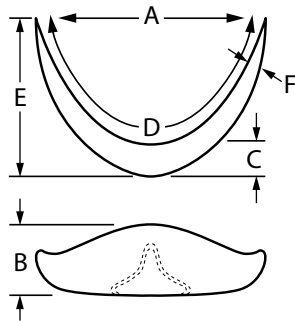

Flowers Mandibular Glove®

Posterior implant surface matches the anatomical variations of the anterior surface of the mandible. Provides anterior chin augmentation while slightly tilting the chin mound upward. Blends in laterally, with no appreciable lateral augmentation.

Cat. No.	Size	A	B	C	D	E	F
FMG-VXS	X-Small	6.0	1.75	0.50	9.0	3.7	0.2
FMG-VS	Small	6.0	1.75	0.60	9.0	3.8	0.3
FMG-VM	Medium	6.0	1.75	0.80	10.0	4.4	0.3
FMG-VL	Large	6.1	1.75	1.00	10.0	4.6	0.4
FMG-VXL	X-Large	6.3	1.75	1.40	10.8	5.4	0.5
FMG-VSIZ-NS	Sizers	Complete Set					

Dimensions in centimeters

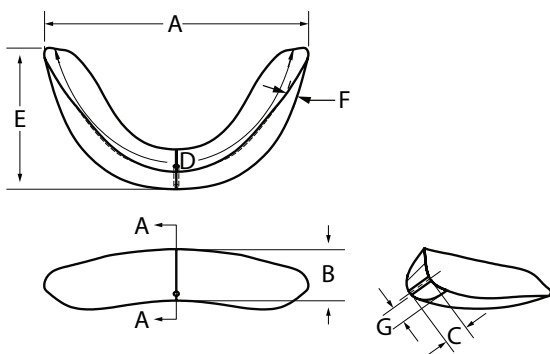

Vertical Lengthening Chin

Designed by Barry L. Eppley, MD, DMD

Designed to address a three-dimensional chin deficiency. Implant secures to the lower edge of the anterior jawline to provide both a downward 45-degree augmentation and a horizontal projection. Creates a more elongated face and triangular jawline-chin shape.

Cat. No.	Size	A	B	C	D	E	F	G
VLCS	Small	6.5	1.4	0.79	9.0	3.6	0.52	0.55
VLGM	Medium	7.3	1.6	1.0	10.5	4.7	0.50	0.60
VLC-L	Large	7.8	1.8	1.2	12.0	5.2	0.60	0.70
VLC-SIZ-NS	Sizers	Complete Set						

Dimensions in centimeters

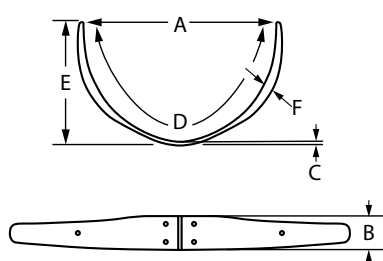

Mandibular Pre Jowl®

Provides augmentation in pre-jowl sulcus with no additional anterior chin augmentation.

Cat. No.	Size	A	B	C	D	E	F
MPJ-S	Small	6.0	1.0	0.10	10.5	4.2	0.3
MPJ-M	Medium	6.0	1.0	0.10	11.0	4.3	0.4
MPJ-L	Large	6.0	1.0	0.10	11.0	4.3	0.5
MPJ-XL	X-Large	6.0	1.0	0.10	12.0	4.6	0.6
MPJ-SIZ-NS	Sizers	Complete Set					

Dimensions in centimeters

Mandibular Pre Jowl Chin™

Provides anterior chin augmentation with a subtle increase in lateral fullness precisely positioned to augment the pre-jowl sulcus. Posterior implant surface allows for a pronounced symphyseal ridge. Can be used with Glasgold Wafer™ for additional anterior augmentation.

Cat. No.	Size	A	B	C	D	E	F
MPJCS	Small	6.0	1.5	0.65	10.0	4.0	0.33
MPJCM	Medium	6.0	1.5	0.80	10.4	4.3	0.40
MPJCL	Large	6.0	1.5	0.95	10.5	4.8	0.50
MPJCLXL	X-Large	6.0	1.5	1.10	11.0	5.0	0.56
MPJCSIZ-NS	Sizers	Complete Set					

Dimensions in centimeters

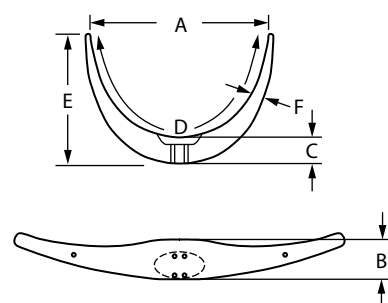

Terino Square Chin - Style I

Provides anterior chin augmentation with a square profile.

Cat. No.	Size	A	B	C	D	E	F	G	H
TSCI-S	Small	6.6	1.3	0.60	9.8	4.1	0.4	4.0	0.70
TSCI-M	Medium	6.5	1.4	0.70	10.9	4.8	0.3	4.2	0.80
TSCI-L	Large	6.6	1.6	0.80	12.0	5.4	0.3	4.6	0.93
TSCI-XL	X-Large	6.9	1.6	1.10	12.8	5.8	0.4	4.2	1.20
TSCI-SIZ-NS	Sizers	Complete Set							

Dimensions in centimeters

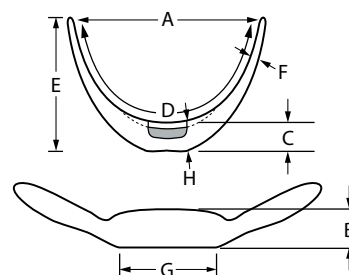

Terino Square Chin - Style II

A more strongly defined square profile than Style I.

Cat. No.	Size	A	B	C	D	E	F	G	H
TSCII-S	Small	7.8	1.5	0.47	11.5	4.3	0.4	4.0	0.74
TSCII-M	Medium	8.0	1.5	0.50	12.8	5.0	0.4	5.4	0.80
TSCII-L	Large	9.4	1.5	0.55	13.3	4.9	0.4	5.1	0.91
TSCII-XL	X-Large	9.0	1.5	0.65	15.0	6.2	0.4	5.3	1.00
TSCII-SIZ-NS	Sizers	Complete Set							

Dimensions in centimeters

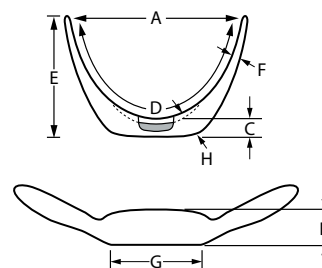

CHIN IMPLANTS

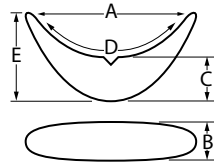

Anatomical Chin

Central chin augmentation. Short lateral extensions blend into mandible. ePTFE-Coated Anatomical Chin available on page 18.

Cat. No.	Size	A	B	C	D	E
AC-S	Small	4.7	1.2	0.60	6.0	2.1
AC-M	Medium	5.3	1.2	0.90	6.6	2.5
AC-L	Large	5.1	1.2	1.00	6.2	2.5
AC-XL	X-Large	5.3	1.2	1.20	6.6	2.8
AC-SIZ-NS	Sizes	Complete Set				

Dimensions in centimeters

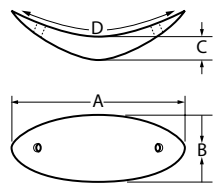

Curvilinear Silicone Chin

Central chin augmentation with no lateral component. ePTFE-Coated Curvilinear Chin available on page 18.

Cat. No.	Size	A	B	C	D
CSCXS	X-Small	3.1	1.1	0.45	3.0
CSC-S	Small	3.2	1.4	0.65	3.3
CSC-M	Medium	3.6	1.4	0.65	4.0
CSC-L	Large	4.4	1.4	0.65	4.8
CSC-XL	X-Large	4.0	1.5	0.70	4.5
CSC-SIZ-NS	Sizes	Complete Set			

Dimensions in centimeters

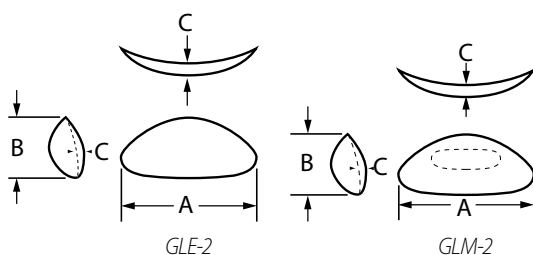

Glasgold Wafer™

Provides 2mm additional anterior projection for Extended Anatomical Chin, Terino Extended Anatomical™ Chin (GLE-2) and Pre Jowl Chin™ (GLM-2).

Cat. No.	Size	A	B	C
GLE-2	2mm	3.6	1.1	0.2
GLM-2	2mm	3.6	1.1	0.2

Dimensions in centimeters

Tips on Choosing the Appropriate Implantech Chin Implant

Table 1. DESIRED OUTCOME – Compare the three dimensions of projection, by style and size

Anterior Projection	Cat. No.	X-Small	Small	Medium	Large	X-Large
Terino Extended Anatomical™ Chin	TEAC		0.38	0.46	0.58	0.64
Conform™ Extended Anatomical Chin	CEAC		0.43	0.50	0.60	0.75
* Extended Anatomical Chin	EAC		0.45	0.50	0.60	0.75
* Curvilinear Silicone Chin	CSC	0.45	0.65	0.65	0.65	0.70
Flowers Mandibular Glove®	FMG	0.50	0.60	0.80	1.00	1.40
* Anatomical Chin (no lateral projection)	AC		0.60	0.90	1.00	1.20
Mandibular Pre Jowl Chin™	MPJC		0.65	0.80	0.95	1.10
ePTFE Extended Chin	ESEC		0.70	0.90	1.05	
Vertical Lengthening Chin	VLC		0.79	1.00	1.20	
Glasgold Wafer™	GLE-2/GLM-2	Provides additional 0.20 cm to EAC, TEAC and MPJC				
Lateral Projection	Cat. No.	X-Small	Small	Medium	Large	X-Large
Conform™ Extended Anatomical Chin	CEAC		0.20	0.30	0.30	0.30
Flowers Mandibular Glove®	FMG	0.20	0.30	0.30	0.40	0.50
* Extended Anatomical Chin	EAC		0.20	0.40	0.40	0.50
Terino Extended Anatomical™ Chin	TEAC		0.30	0.30	0.30	0.40
ePTFE Extended Chin	ESEC		0.30	0.31	0.32	
Mandibular Pre Jowl® (no ant. proj. or vert. ht.)	MPJ		0.30	0.40	0.50	0.60
Mandibular Pre Jowl Chin™	MPJC		0.33	0.40	0.50	0.56
Vertical Lengthening Chin	VLC		0.52	0.50	0.60	
Vertical Height	Cat. No.	X-Small	Small	Medium	Large	X-Large
Terino Extended Anatomical™ Chin	TEAC		1.00	1.20	1.30	1.40
* Extended Anatomical Chin	EAC		1.00	1.20	1.40	1.40
Conform™ Extended Anatomical Chin	CEAC		1.00	1.20	1.35	1.50
* Anatomical Chin	AC		1.20	1.20	1.20	1.20
ePTFE Extended Chin	ESEC		1.35	1.55	1.85	
* Curvilinear Silicone Chin	CSC	1.10	1.40	1.40	1.40	1.50
Vertical Lengthening Chin	VLC		1.40	1.60	1.80	
Mandibular Pre Jowl Chin™	MPJC		1.50	1.50	1.50	1.50
Flowers Mandibular Glove®	FMG	1.75	1.75	1.75	1.75	1.75

* ePTFE-Coated versions of these implants have the same dimensions.

Dimensions in centimeters

Other Desired Characteristics

Square Appearance

Terino Extended Anatomical™ Chin (TEAC)
 Terino Square Chin-Style I (TSCI)
 Terino Square Chin-Style II (TSCII)

Slight tilt upwards

Flowers Mandibular Glove® (FMG)

Vertical Dimension

Vertical Lengthening Chin (VLC)

Stability

Implants with holes for integration/fixation

Curvilinear Silicone Chin (CSC)
 Mandibular Pre Jowl® (MPJ)
 Mandibular Pre Jowl Chin™ (MPJC)

Conforming (more flexible)

Conform™ Extended Anatomical Chin (CEAC)

Allows tissue attachment

ePTFE-Coated Extended Anatomical Chin (ePTFE-EAC)
 ePTFE-Coated Anatomical Chin (ePTFE-AC)
 ePTFE-Coated Curvilinear Chin (ePTFE-CSC)
 ePTFE Extended Chin (ESEC)

Tips on Choosing the Appropriate Implantech Chin Implant

Table 2. ANTERIOR PROJECTION – Regardless of style, from least to greatest

Implant Style	Cat. No.	Size	Anterior Projection
Terino Extended Anatomical™ Chin	TEAG-S	Small	0.38
Conform™ Extended Anatomical Chin	CEAG-S	Small	0.43
* Extended Anatomical Chin	EAG-S	Small	0.45
* Curvilinear Silicone Chin	CSC-XS	X-Small	0.45
Terino Extended Anatomical™ Chin	TEAG-M	Medium	0.46
Conform™ Extended Anatomical Chin	CEAG-M	Medium	0.50
* Extended Anatomical Chin	EAG-M	Medium	0.50
Flowers Mandibular Glove®	FMG-VXS	X-Small	0.50
Terino Extended Anatomical™ Chin	TEAG-L	Large	0.58
Conform™ Extended Anatomical Chin	CEAG-L	Large	0.60
* Extended Anatomical Chin	EAG-L	Large	0.60
Flowers Mandibular Glove®	FMG-VS	Small	0.60
* Anatomical Chin	AG-S	Small	0.60
Terino Extended Anatomical™ Chin	TEAG-XL	X-Large	0.64
Mandibular Pre Jowl Chin™	MPJG-S	Small	0.65
* Curvilinear Silicone Chin	CSC-S	Small	0.65
* Curvilinear Silicone Chin	CSC-M	Medium	0.65
* Curvilinear Silicone Chin	CSC-L	Large	0.65
ePTFE Extended Chin	ESEG-S	Small	0.70
* Curvilinear Silicone Chin	CSC-XL	X-Large	0.70
Conform™ Extended Anatomical Chin	CEAG-XL	X-Large	0.75
* Extended Anatomical Chin	EAG-XL	X-Large	0.75
Vertical Lengthening Chin	VLG-S	Small	0.79
Flowers Mandibular Glove®	FMG-VM	Medium	0.80
Mandibular Pre Jowl Chin™	MPJG-M	Medium	0.80
* Anatomical Chin	AG-M	Medium	0.90
ePTFE Extended Chin	ESEG-M	Medium	0.90
Mandibular Pre Jowl Chin™	MPJG-L	Large	0.95
Vertical Lengthening Chin	VLG-M	Medium	1.00
Flowers Mandibular Glove®	FMG-VL	Large	1.00
* Anatomical Chin	AG-L	Large	1.00
ePTFE Extended Chin	ESEG-L	Large	1.05
Mandibular Pre Jowl Chin™	MPJG-XL	X-Large	1.10
Vertical Lengthening Chin	VLG-L	Large	1.20
* Anatomical Chin	AG-XL	X-Large	1.20
Flowers Mandibular Glove®	FMG-VXL	X-Large	1.40

* ePTFE-Coated versions of these implants have the same dimensions.
Chin Sizing Guide suggested by Steven J. Pearlman, MD, FACS

Dimensions in centimeters

Conform™ Mandibular Angle

Compared to the Lateral Mandibular Angle (TMA), this implant's shortened ramus, longer mandibular dimensions and slightly more lateral projection put more emphasis on the angle prominence and mandibular definition. Patented Conform™ grid pattern readily adapts to the gonial angle. Specify Catalog No. for "Left (L)" or "Right (R)". Single-packed (not in pairs). Save by purchasing a pair.

Cat. No.	A	B	C	D	E	F	G
CMA-8L	3.70	0.40	4.70	3.0	3.0	0.8	0.40
CMA-8R	3.70	0.40	4.70	3.0	3.0	0.8	0.40
CMA-10L	3.70	0.40	4.80	3.0	3.0	1.0	0.40
CMA-10R	3.70	0.40	4.80	3.0	3.0	1.0	0.40
CMA-12L	3.70	0.40	4.90	3.0	3.0	1.2	0.40
CMA-12R	3.70	0.40	4.90	3.0	3.0	1.2	0.40
CMA-14L	3.70	0.40	5.00	3.0	3.0	1.4	0.40
CMA-14R	3.70	0.40	5.00	3.0	3.0	1.4	0.40
CMA-SIZ-NS	Sizers	Complete Set					

Dimensions in centimeters

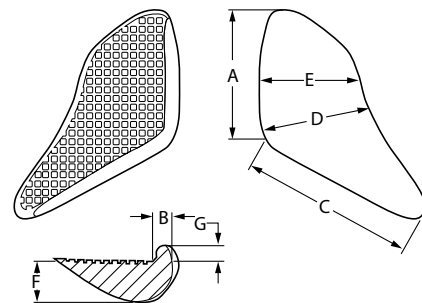

Widening Mandibular Angle

Designed by Barry L. Eppley, MD, DMD

Features less lateral projection than the Conform™ Mandibular Angle (CMA) and a more defined angle prominence. Extended mandible and shortened ramus edges help enable a more ideal fit to jaw angle. Specify Catalog No. for "Left (L)" or "Right (R)." Single-packed (not in pairs). Save by purchasing a pair.

Cat. No.	A	B	C
WMA-5L	3.2	0.5	4.0
WMA-5R	3.2	0.5	4.0
WMA-7L	3.3	0.7	4.4
WMA-7R	3.3	0.7	4.4
WMA-10L	3.6	1.0	4.6
WMA-10R	3.6	1.0	4.6
WMA-SIZ-NS	Sizers	Complete Set	

Dimensions in centimeters

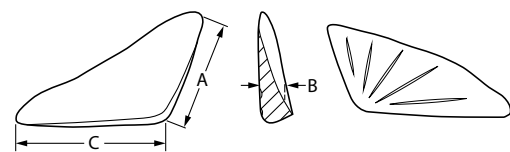

Vertical Mandibular Angle

Designed by Barry L. Eppley, MD, DMD

An innovative jaw implant design that creates a distinct jaw angle shape below the patient's natural jawline. Vertically lengthens the short ramus to more clearly define the jaw angle. This also results in a more aesthetically pleasing widened lower face. Specify Catalog No. for "Left (L)" or "Right (R)." Single-packed (not in pairs). Save by purchasing a pair.

Cat. No.	A	B	C	D
VMA-7L	2.5	0.4	4.5	0.7
VMA-7R	2.5	0.4	4.5	0.7
VMA-11L	3.0	0.5	5.0	1.1
VMA-11R	3.0	0.5	5.0	1.1
VMA-13L	3.6	0.5	5.5	1.3
VMA-13R	3.6	0.5	5.5	1.3
VMA-SIZ-NS	Sizers	Complete Set		

Dimensions in centimeters

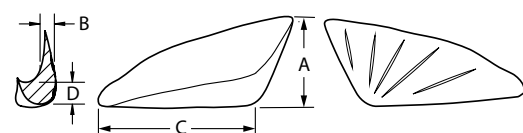

MANDIBULAR ANGLE IMPLANTS

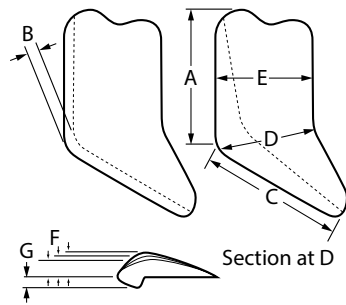

Lateral Mandibular Angle™

Lateral augmentation of mandibular angle (dimension F). Specify Catalog No. for "Left (L)" or "Right (R)." Lateral Mandibular Implants are single-packed (not in pairs).

Cat. No.	A	B	C	D	E	F	G
TMA-4L/8	4.5	0.4	4.5	3.5	3.0	0.8	0.4
TMA-4R/8	4.5	0.4	4.5	3.5	3.0	0.8	0.4
TMA-4L/10	4.5	0.4	4.5	3.5	3.0	1.0	0.4
TMA-4R/10	4.5	0.4	4.5	3.5	3.0	1.0	0.4
TMA-4L/12	4.5	0.4	4.5	3.5	3.0	1.2	0.4
TMA-4R/12	4.5	0.4	4.5	3.5	3.0	1.2	0.4
TMA-L-SIZ-NS	Sizers	Complete Set					

Dimensions in centimeters

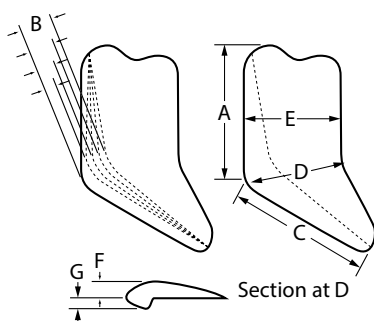

Posterior Mandibular Angle™

Augments posterior mandibular angle (dimension B) with minor lateral augmentation (dimension F). Specify Catalog No. for "Left (L)" or "Right (R)." Posterior Mandibular Implants are single-packed (not in pairs).

Cat. No.	A	B	C	D	E	F	G
TMA-4L	4.5	0.4	4.5	3.5	3.0	0.36	0.4
TMA-4R	4.5	0.4	4.5	3.5	3.0	0.36	0.4
TMA-6L	4.5	0.6	4.5	3.5	3.0	0.36	0.4
TMA-6R	4.5	0.6	4.5	3.5	3.0	0.36	0.4
TMA-8L	4.5	0.8	4.5	3.5	3.0	0.36	0.4
TMA-8R	4.5	0.8	4.5	3.5	3.0	0.36	0.4
TMA-10L	4.5	1.0	4.5	3.5	3.0	0.36	0.4
TMA-10R	4.5	1.0	4.5	3.5	3.0	0.36	0.4

Dimensions in centimeters

Conform Binder Submalar®

Making it softer and more flexible than the standard silicone implant, the patented Conform™ grid pattern readily adapts to the underlying facial structure. Augments the submalar region for a more youthful appearance. Sold in pairs.

Cat. No.	Size	A	B	C
CBSM-S	Small	4.4	1.5	0.4
CBSM-M	Medium	4.9	1.8	0.5
CBSM-L	Large	5.4	1.9	0.6
CBSM-XL	X-Large	5.9	2.1	0.7
CBSM-SIZ-NS	Sizers	Complete Set		

Dimensions in centimeters

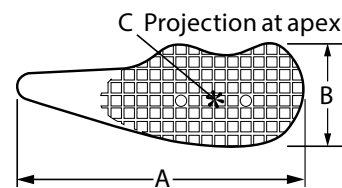

Binder Submalar®

Elevates and repositions the overlying midfacial soft tissue in an anterior and superior position for a more youthful appearance. Adds lower midfacial fullness while softening the nasolabial fold. Sold in pairs.

Cat. No.	Size	A	B	C
BSM-S	Small	4.0	1.6	0.45
BSM-M	Medium	4.5	1.8	0.50
BSM-L	Large	5.0	2.0	0.56
BSM-XL	X-Large	5.3	2.2	0.61
BSM-SIZ-NS	Sizers	Complete Set		

Dimensions in centimeters

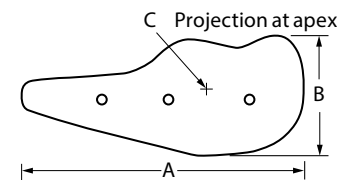

Binder Submalar® II

Same aesthetic benefit as Binder Submalar®, but designed to fit more inferiorly into the submalar space to provide natural augmentation in patients with high cheekbones and sunken cheeks. Sold in pairs. ePTFE-Coated Binder Submalar® II available on page 18.

Cat. No.	Size	A	B	C
BSMII-S	Small	4.0	2.1	0.40
BSMII-M	Medium	4.4	2.3	0.45
BSMII-L	Large	4.9	2.5	0.54
BSMII-XL	X-Large	5.2	2.8	0.54
BSMII-SIZ-NS	Sizers	Complete Set		

Dimensions in centimeters

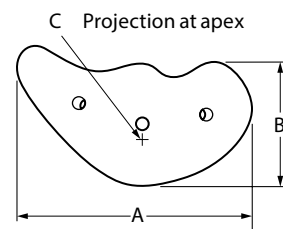

MIDFACIAL IMPLANTS

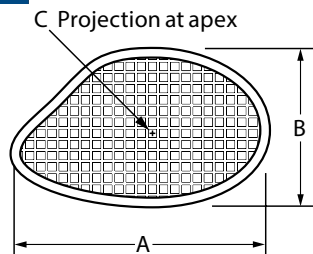

Conform Terino Malar Shell®

Augments the volume deficient midface for a more aesthetic, youthful and balanced look. Soft and flexible, the patented Conform™ design enables the implant to adapt to the underlying midfacial structure. Sold in pairs.

Cat. No.	Size	A	B	C
CTMS-S4	Small	4.8	2.3	0.4
CTMS-M4	Medium	5.1	2.8	0.4
CTMS-L4	Large	5.2	3.3	0.4
CTMS-XL4	X-Large	5.7	3.4	0.4
CTMS-SIZ-NS	Sizers	Complete Set		

Dimensions in centimeters

Terino Malar Shell®

Broad surface area with fine, non-palpable edges for a smooth transition between the implant and underlying bone. Ideal for augmenting patients with malar hypoplasia. Sold in pairs. ePTFE-Coated Terino Malar Shell® available on page 18.

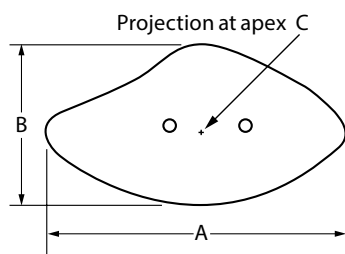

Cat. No.	Size	A	B	C
TMS-S3	Small	4.8	2.3	0.3
TMS-S4	Small	4.8	2.3	0.4
TMS-M3	Medium	5.1	2.8	0.3
TMS-M4	Medium	5.1	2.8	0.4
TMS-M5	Medium	5.1	2.8	0.5
TMS-L3	Large	5.2	3.3	0.3
TMS-L4	Large	5.2	3.3	0.4
TMS-L5	Large	5.2	3.3	0.5
TMS-L6	Large	5.2	3.3	0.6
TMS-XL4	X-Large	6.0	3.7	0.4
TMS-XL5	X-Large	6.0	3.7	0.5
TMS-XL6	X-Large	6.0	3.7	0.6
TMS-XL7	X-Large	6.0	3.7	0.7
TMS-SIZ-NS	Sizers	Set of 0.4cm Projection Sizers		

Dimensions in centimeters

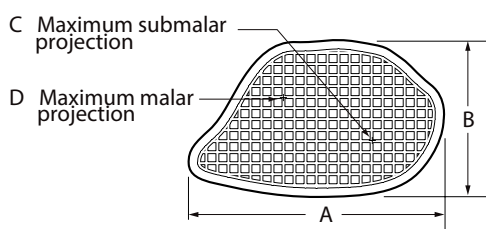

Conform™ Midfacial

With the added benefit of the soft and flexible patented Conform™ grid pattern, this midfacial implant augments both the malar and submalar region for a fuller, younger looking face. Sold in pairs.

Cat. No.	Size	A	B	C	D
CCSM-XS	X-Small	3.4	2.0	0.39	0.20
CCSM-S	Small	4.1	2.5	0.47	0.27
CCSM-M	Medium	4.7	2.7	0.53	0.30
CCSM-L	Large	5.1	3.0	0.56	0.32
CCSM-XL	X-Large	5.5	3.2	0.60	0.40
CCSM-SIZ-NS	Sizers	Complete Set			

Dimensions in centimeters

Combined Submalar Shell™

Augments entire midfacial area by incorporating the features of the Terino Malar Shell® and the Binder Submalar®. Ideal for patients with both malar hypoplasia and midfacial soft-tissue deficiencies. Sold in pairs.

Cat. No.	Size	A	B	C	D												
CSM-S	Small	4.4	3.0	0.40	0.30												
CSM-M	Medium	4.9	3.3	0.50	0.40												
CSM-L	Large	5.4	3.7	0.60	0.50 </tr <tr> <td>CSM-XL</td> <td>X-Large</td> <td>5.8</td> <td>4.2</td> <td>0.70</td> <td>0.60</td> </tr> <tr> <td>CSM-SIZ-NS</td> <td>Sizers</td> <td colspan="4">Complete Set</td> </tr>	CSM-XL	X-Large	5.8	4.2	0.70	0.60	CSM-SIZ-NS	Sizers	Complete Set			
CSM-XL	X-Large	5.8	4.2	0.70	0.60												
CSM-SIZ-NS	Sizers	Complete Set															

Dimensions in centimeters

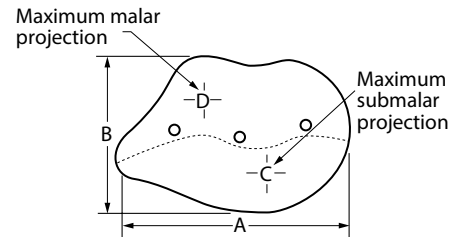

Flowers Tear Trough®

Augments the prominent suborbital groove caused by bony hypoplasia and depressions. Sold in pairs.

Cat. No.	Size	A	B	C
FTT-S	Small	4.2	2.3	0.3
FTT-M	Medium	4.2	2.3	0.4
FTT-L	Large	4.8	2.6	0.5
FTT-SIZ-NS	Sizers	Complete Set		

Dimensions in centimeters

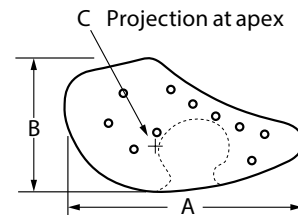

Extended Flowers Tear Trough®

Augments the prominent suborbital groove caused by bony hypoplasia and depressions, with continuous augmentation into the cheek area. Sold in pairs.

Cat. No.	Size	A	B	C
EFTT-L	Extended	5.8	2.6	0.51

Dimensions in centimeters

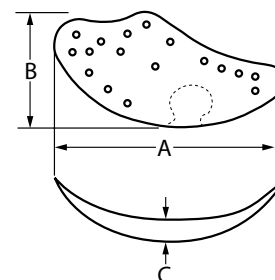

TEMPORAL IMPLANTS

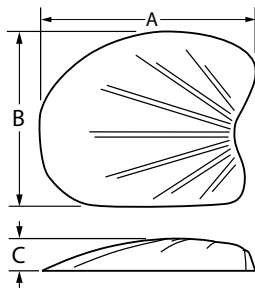

Temporal Shell

Designed by Barry L. Eppley, MD, DMD

An ideal solution for temporal hollowing due to genetics or trauma. Soft and flexible, the silicone Temporal Shell provides soft-tissue volume (muscle enhancement) for an aesthetically pleasing appearance. Specify Catalog No. for "Left (L)" or "Right (R)". Single-packed (not in pairs). Save by purchasing a pair.

Cat. No.	A	B	C
TS-04L	4.7	3.9	0.4
TS-04R	4.7	3.9	0.4
TS-07L	4.7	3.9	0.7
TS-07R	4.7	3.9	0.7
TS-09L	5.5	4.5	0.9
TS-09R	5.5	4.5	0.9
TS-SIZ-NS	Sizers	Complete Set	

Dimensions in centimeters

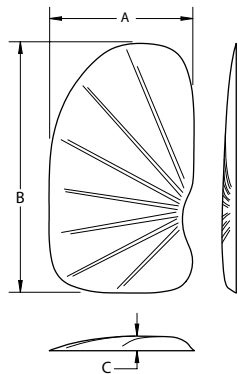

Temporal Shell – Extended

Designed by Barry L. Eppley, MD, DMD

The extended temporal implant provides augmentation to both upper and lower temporal regions. From the top of the zygomatic arch to the anterior temporal line of the forehead, it provides correction of temporal hollowing through augmentation of the full vertical length of the muscle. Its tapering design allows the implant to blend smoothly into the temporal region without visible edges. Specify Catalog No. for "Left (L)" or "Right (R)." Single-packed (not in pairs). Save by purchasing a pair.

Cat. No.	A	B	C
TS-04EL	4.0	7.0	0.4
TS-04ER	4.0	7.0	0.4
TS-06EL	4.5	7.5	0.6
TS-06ER	4.5	7.5	0.6
TSE-SIZ-NS	Sizers	Complete Set	

Dimensions in centimeters

Flowers Dorsal Nasal

Provides mid-dorsal augmentation for central nasal depressions.
ePTFE-Coated Flowers Dorsal Nasal available on page 19.

Cat. No.	Size	A	B	C
FDI-1.5	Small	4.3	1.00	0.15
FDI-2.5	Sm-Med	4.4	1.05	0.25
FDI-3.5	Medium	4.4	1.10	0.35
FDI-4.5	Large	4.4	1.20	0.45
FDI-SIZ-NS	Sizers	Complete Set		

Dimensions in centimeters

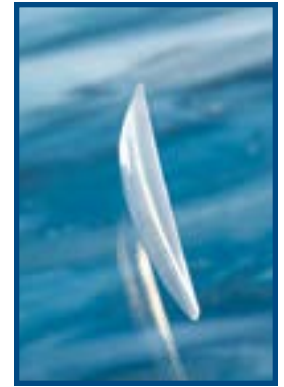
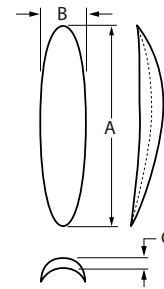

Rizzo Dorsal Nasal

Provides full dorsal augmentation.

Cat. No.	Size	A	B	C	D	E	F	G
RDI-XS	X-Small	4.5	2.25	0.20	0.15	0.5	0.7	0.9
RDI-S	Small	4.5	2.25	0.30	0.25	0.5	0.7	0.9
RDI-M	Medium	4.5	2.25	0.40	0.35	0.5	0.7	0.9
RDI-L	Large	4.5	2.25	0.47	0.45	0.5	0.7	1.0
RDI-XL	X-Large	4.5	2.25	0.50	0.52	0.5	0.7	1.0
RDI-SIZ-NS	Sizers	Complete Set						

Dimensions in centimeters

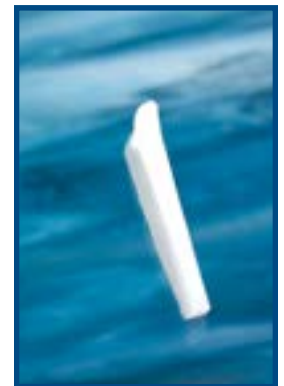
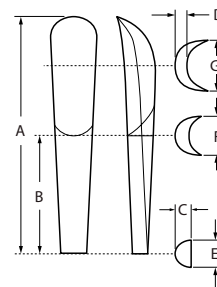

Peri-Pyiform™

A premaxillary implant designed to augment the perialar area around the pyriform aperture. Adds anterior projection to the premaxilla and provides a platform for the nasal base.

Cat. No.	Size	A	B	C	D
BPI-S	Small	3.8	1.5	2.8	0.53
BPI-M	Medium	3.6	1.8	2.4	0.57
BPI-L	Large	3.9	2.1	2.8	0.65

Dimensions in centimeters

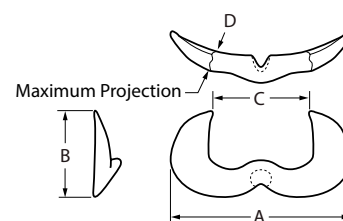

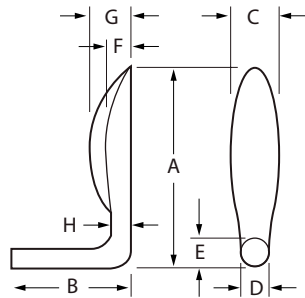

Voloshin Dorsal Columella

Augments and reconstructs the nasal dorsum and the nasal tip. Fabricated in a soft and pliable opaque silicone elastomer. ePTFE-Coated Voloshin Dorsal Columella available on page 19.

Cat. No.	A	B	C	D	E	F	G	H
VSDC-001	5.0	3.0	1.1	0.7	0.4	0.22	0.40	0.4
VSDC-002	5.4	3.0	1.0	0.7	0.4	0.20	0.40	0.4
VSDC-003	4.9	3.2	1.0	0.7	0.4	0.43	0.70	0.6
VSDC-004	5.2	3.2	1.2	0.7	0.4	0.50	0.75	0.6
VSDC-010	5.2	3.3	1.0	0.7	0.4	0.35	0.55	0.6
VSDC-SIZ-NS	Sizers	Complete Set						

Dimensions in centimeters

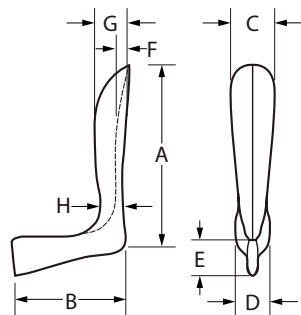

Anatomical Nasal Implant

Designed by Nazih M. Haddad, MD

Provides a natural-looking tip and fullness to the nasal dorsum. Opens up the columella labial angle. Thin, tapered wings drape over the dorsal sides for implant stability.

Cat. No.	A	B	C	D	E	F	G	H
ANI-010	3.7	2.3	0.80	0.66	0.80	0.20	0.58	0.42
ANI-020	4.0	2.5	0.90	0.72	0.90	0.21	0.65	0.45
ANI-030	4.4	2.7	1.00	0.79	0.95	0.23	0.70	0.50
ANI-031	4.4	2.7	1.00	0.79	0.95	0.42	0.70	0.50
ANI-040	4.7	2.9	1.05	0.84	1.00	0.23	0.75	0.55
ANI-041	4.7	2.9	1.05	0.84	1.00	0.45	0.75	0.55
ANI-SIZ-NS	Sizers	Complete Set						

Dimensions in centimeters

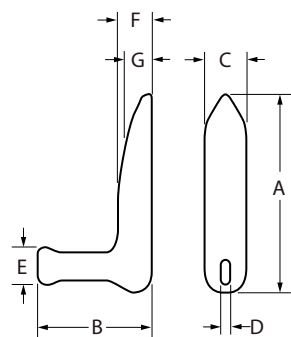

Dorsal Columella

Carvable to fit each patient. Available in firm (F) and soft (S) durometers.

Cat. No.	Type	A	B	C	D	E	F	G
DCI-03F	Firm	5.8	3.0	1.1	0.3	0.9	0.8	0.6
DCI-03S	Soft	5.8	3.0	1.1	0.3	0.9	0.8	0.6

Dimensions in centimeters

ePTFE PRODUCTS

expanded polytetrafluoroethylene



Composite™ Facial Implants

Made of flexible silicone fully encased in a .3mm layer of expanded polytetrafluoroethylene (ePTFE), our Composite™ Facial Implants feature the best of both materials: silicone's shape retention and aesthetic feel plus the stabilizing tissue attachment promoted by ePTFE.

Solid ePTFE Facial Implants

Comprised of solid yet supple ePTFE, these implants feature a microporous nature that permits tissue in-growth for a more stable, predictable outcome. Moreover, this proven biomaterial promotes a natural look and feel.

ePTFE Sheeting

Sheeting of ePTFE is biostable, biocompatible and hydrophobic, making it versatile and effective for a wide range of applications. Implantech's ePTFE sheeting comes in a variety of useful lengths, widths and thicknesses.

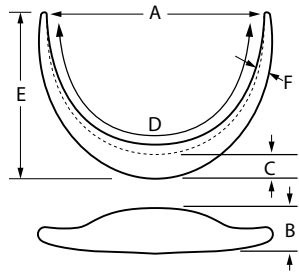

ePTFE-Coated Extended Anatomical Chin

Full lateral arms blend into mandible.

Cat. No.	Size	A	B	C	D	E	F
ePTFE-EAG-S	Small	5.5	1.0	0.45	9.0	3.7	0.2
ePTFE-EAG-M	Medium	5.6	1.2	0.50	9.5	4.2	0.4
ePTFE-EAG-L	Large	6.8	1.4	0.60	11.0	4.8	0.4
ePTFE-EAG-XL	X-Large	6.0	1.4	0.75	11.0	5.1	0.5
EAG-SIZ-NS	Sizers	Complete Set (silicone)					

Dimensions in centimeters

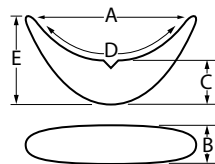

ePTFE-Coated Anatomical Chin

Central chin augmentation. Short lateral extensions blend into mandible.

Cat. No.	Size	A	B	C	D	E
ePTFE-AC-S	Small	4.7	1.2	0.60	6.0	2.1
ePTFE-AC-M	Medium	5.3	1.2	0.90	6.6	2.5
ePTFE-AC-L	Large	5.1	1.2	1.00	6.2	2.5
ePTFE-AC-XL	X-Large	5.3	1.2	1.20	6.6	2.8
AC-SIZ-NS	Sizers	Complete Set (silicone)				

Dimensions in centimeters

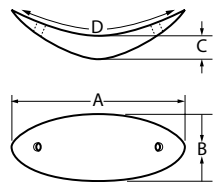

ePTFE-Coated Curvilinear Chin

Central chin augmentation with no lateral component.

Cat. No.	Size	A	B	C	D
ePTFE-CSC-XS	X-Small	3.1	1.1	0.45	3.0
ePTFE-CSC-S	Small	3.2	1.4	0.65	3.3
ePTFE-CSC-M	Medium	3.6	1.4	0.65	4.0
ePTFE-CSC-L	Large	4.4	1.4	0.65	4.8
ePTFE-CSC-XL	X-Large	4.0	1.5	0.70	4.5
CSC-SIZ-NS	Sizers	Complete Set (silicone)			

Dimensions in centimeters

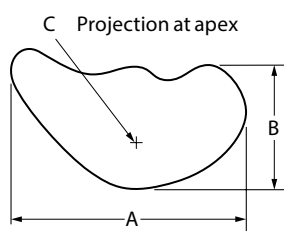

ePTFE-Coated Binder Submalar® II

Designed to fit into the submalar space to provide lower midfacial fullness for patients with prominent cheekbones and sunken cheeks. Elevates and repositions the overlying midfacial soft tissue while softening the nasolabial fold. Sold in pairs.

Cat. No.	Size	A	B	C
ePTFE-BSMII-S	Small	4.0	2.1	0.40
ePTFE-BSMII-M	Medium	4.4	2.3	0.45
ePTFE-BSMII-L	Large	4.9	2.5	0.46
ePTFE-BSMII-XL	X-Large	5.2	2.8	0.54
BSMII-SIZ-NS	Sizers	Complete Set (silicone)		

Dimensions in centimeters

ePTFE-Coated Terino Malar Shell®

Broad surface area with fine, non-palpable edges for a smooth transition between the implant and underlying bone. Ideal for augmenting patients with malar hypoplasia. Sold in pairs.

Cat. No.	Size	A	B	C
ePTFE-TMS-S	Small	4.8	2.3	0.4
ePTFE-TMS-M	Medium	5.1	2.8	0.4
ePTFE-TMS-L	Large	5.2	3.3	0.4
ePTFE-TMS-XL	X-Large	5.7	3.6	0.4
TMS-SIZ-NS	Sizers	Complete Set (silicone)		

Dimensions in centimeters

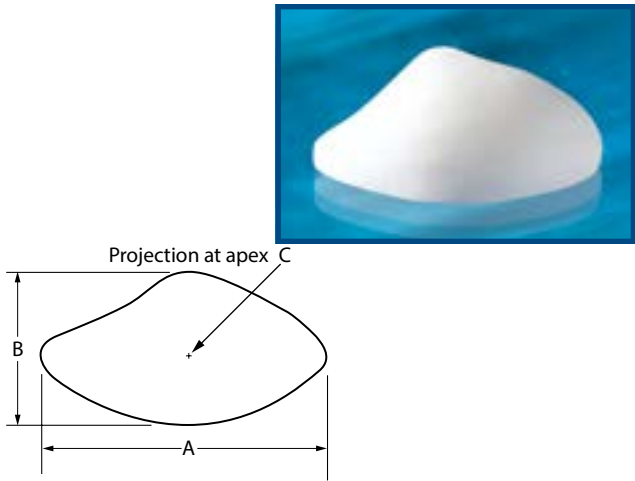

ePTFE-Coated Flowers Dorsal Nasal

Provides mid-dorsal augmentation for central nasal depressions.

Cat. No.	Size	A	B	C
ePTFE-FDI-1.5	Small	4.3	1.00	0.15
ePTFE-FDI-2.5	Sm-Med	4.4	1.05	0.25
ePTFE-FDI-3.5	Medium	4.4	1.10	0.35
ePTFE-FDI-4.5	Large	4.4	1.10	0.45
FDI-SIZ-NS	Sizers	Complete Set (silicone)		

Dimensions in centimeters

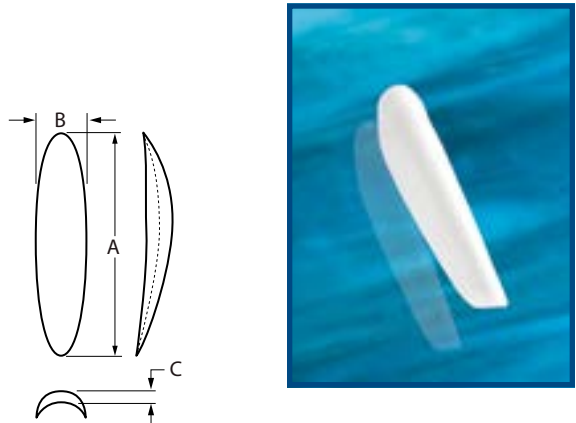

ePTFE-Coated Voloshin Dorsal Columella

Augments and reconstructs the nasal dorsum and the nasal tip.

Cat. No.	A	B	C	D	E	F	G	H
ePTFE-VSDC-001	5.0	3.0	1.1	0.7	0.4	0.22	0.40	0.4
ePTFE-VSDC-002	5.4	3.0	1.0	0.7	0.4	0.20	0.40	0.4
ePTFE-VSDC-003	4.9	3.2	1.0	0.7	0.4	0.43	0.70	0.6
ePTFE-VSDC-004	5.2	3.2	1.2	0.7	0.4	0.50	0.75	0.6
ePTFE-VSDC-010	5.2	3.3	1.0	0.7	0.4	0.35	0.55	0.6
VSDC-SIZ-NS	Sizers	Complete Set (silicone)						

Dimensions in centimeters

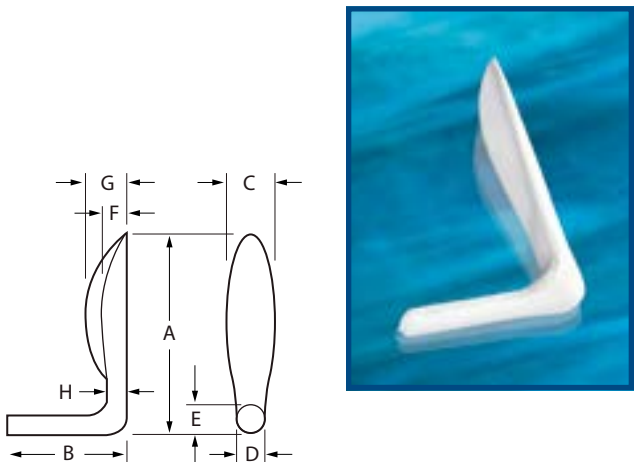

See our silicone implant section starting on page 3

ePTFE FACIAL IMPLANTS

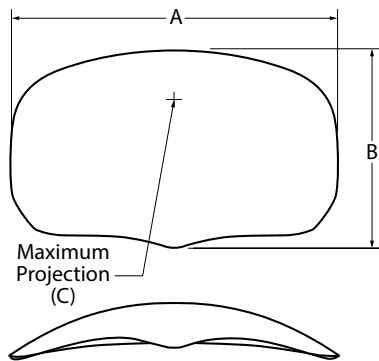

ePTFE Forehead

Correcting forehead depression or an irregular forehead surface, our ePTFE Forehead implant augments the area with an aesthetic curvature in all dimensions. An ancillary benefit is a lift of forehead skin that may be somewhat loose or saggy.

Cat. No.	Size	A	B	C
ESFH-S	Small	10.70	6.70	0.45
ESFH-M	Medium	11.85	7.60	0.45
ESFH-L	Large	13.80	7.70	0.45
ESFH-SIZ-NS	Sizers	Complete Set (silicone)		

Dimensions in centimeters

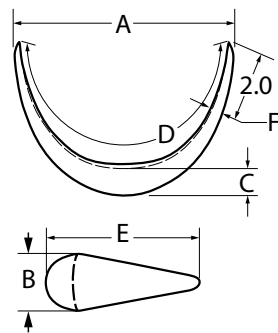

ePTFE Extended Chin

The ePTFE Extended Chin implant adds confident projection to a weak, undersized chin helping to make other facial features look more proportional and give the face greater overall balance.

Cat. No.	Size	A	B	C	D	E	F
ESEC-S	Small	4.85	1.35	0.70	8.50	4.00	0.30
ESEC-M	Medium	5.50	1.55	0.90	9.00	4.40	0.31
ESEC-L	Large	6.20	1.85	1.05	10.00	5.00	0.32
ESEC-SIZ-NS	Sizers	Complete Set (silicone)					

Dimensions in centimeters

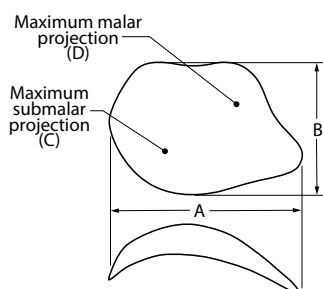

ePTFE Midfacial

Addressing both hypoplasia and a lack of a soft tissue below the cheekbone, the ePTFE Midfacial implant augments both the malar and submalar regions for a fuller, younger look. Sold in pairs.

Cat. No.	Size	A	B	C	D
ESMF-S	Small	4.53	2.82	0.35	0.33
ESMF-M	Medium	5.20	3.10	0.47	0.43
ESMF-L	Large	5.73	3.55	0.55	0.53
ESMF-SIZ-NS	Sizers	Complete Set (silicone)			

Dimensions in centimeters

ePTFE Nasal, Rounded

Our ePTFE Rounded Nasal implant provides augmentation with a full, rounded dorsum.

Cat. No.	Size	A	B	C
ESNR-S23	Small	3.73	1.25	0.23
ESNR-L23	Large	4.90	1.70	0.23
ESNR-S35	Small	3.73	1.50	0.35
ESNR-L35	Large	4.90	1.95	0.35
ESNR-SIZ-NS	Sizers	Complete Set (silicone)		

Dimensions in centimeters

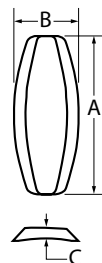

ePTFE Nasal, Pointed

The ePTFE Pointed Nasal implant provides augmentation with a tapered dorsal appearance.

Cat. No.	Size	A	B	C
ESNP-S23	Small	3.73	1.20	0.23
ESNP-L23	Large	4.90	1.60	0.23
ESNP-S35	Small	3.73	1.50	0.35
ESNP-L35	Large	4.90	1.90	0.35
ESNP-SIZ-NS	Sizers	Complete Set (silicone)		

Dimensions in centimeters



ePTFE Premaxillary

Designed to augment the entire central and lateral peri-pyramidal area. Adds anterior projection to the maxilla, repositions the upper lip to a more vertical position and provides a platform for the nasal base.

Cat. No.	Size	A	B	C	D	E	F
ESPM-S	Small	4.50	1.70	3.75	0.35	2.45	0.80
ESPM-M	Medium	4.75	1.70	4.00	0.40	2.70	0.80
ESPM-L	Large	5.00	1.70	4.25	0.50	2.80	0.85
ESPM-SIZ-NS	Sizers	Complete Set (silicone)					

Dimensions in centimeters

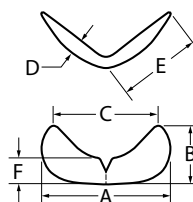

ePTFE Paranasal

The ePTFE Paranasal implant increases projection of the nostril base and decreases the depth of the upper nasolabial folds.

Cat. No.	Size	A	B	C	D
ESPN-S5	Small	1.85	1.40	1.30	0.50
ESPN-M5	Medium	2.00	1.50	1.40	0.50
ESPN-L5	Large	2.20	1.60	1.50	0.50
ESPN-S6	Small	1.85	1.40	1.30	0.60
ESPN-M6	Medium	2.00	1.50	1.40	0.60
ESPN-L6	Large	2.20	1.60	1.50	0.60
ESPN-SIZ-NS	Sizers	Complete Set (silicone)			

Dimensions in centimeters

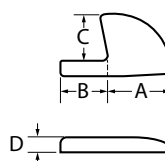

ePTFE SHEETING

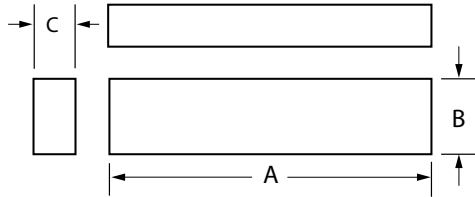

ePTFE Sheeting (Sterile)

Available in various sizes, our ePTFE sheeting is packaged sterile for your surgical needs.

Cat. No.	A	B	C
ePTFE-SHEET-010	8	5	0.1
ePTFE-SHEET-011	8	3	0.1
ePTFE-SHEET-012	9	6	0.1
ePTFE-SHEET-013	12	6	0.1
ePTFE-SHEET-020	8	3	0.2
ePTFE-SHEET-021	8	5	0.2
ePTFE-SHEET-022	9	6	0.2
ePTFE-SHEET-023	12	6	0.2
ePTFE-SHEET-040	10	3	0.4
ePTFE-SHEET-041	6	1.6	0.4
ePTFE-SHEET-060	10	3	0.6
ePTFE-SHEET-061	6	1.6	0.6

Dimensions in centimeters

Actual ePTFE Sheeting sizes:

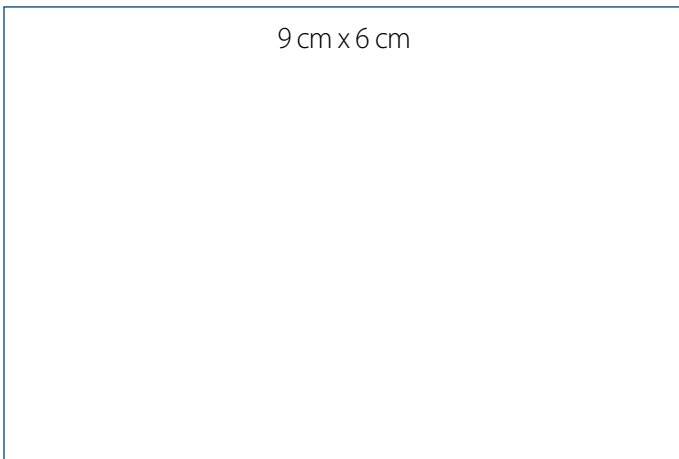

Thickness scale:

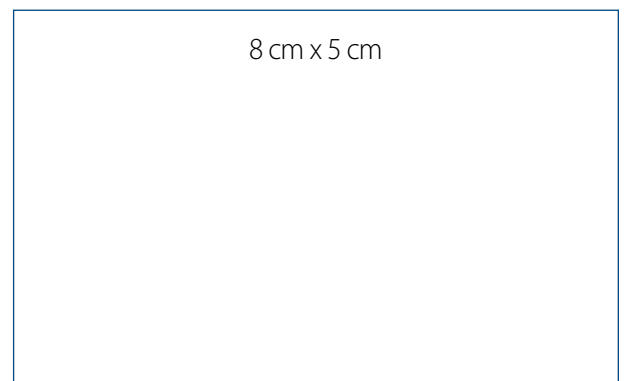
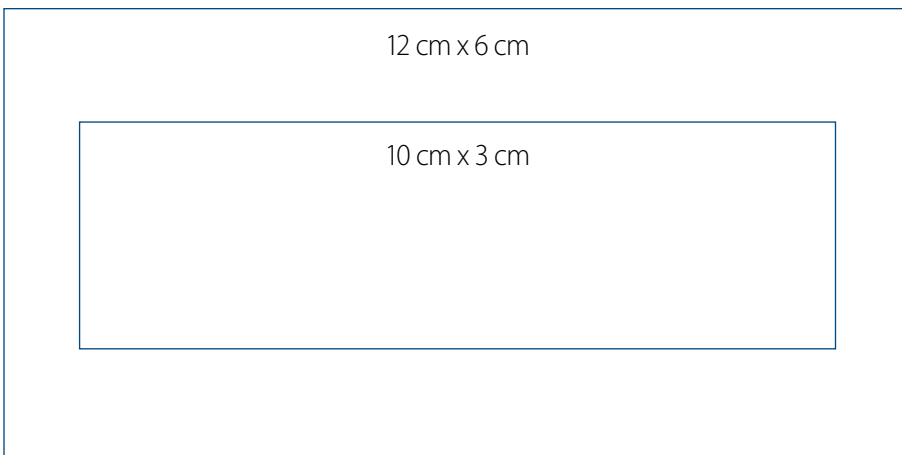
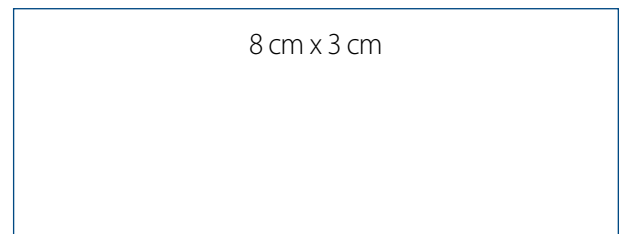
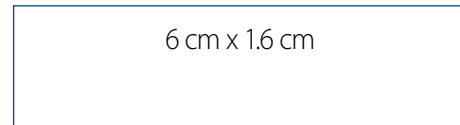
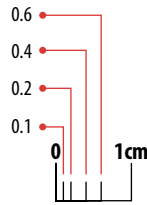

INSTRUMENT-RELATED

In addition to our implantable devices, Implantech offers effective, quality items for your surgical needs.

- Periosteal Elevators – These precision instruments were designed by surgeons for surgeons to form a more optimal facial implant pocket.
- SE-100 Smoke Aspiration Tip – Protect yourself from electrocautery smoke that carries hazardous contaminants, including known carcinogens.

Periosteal Elevators

Elevators are handcrafted in Germany from surgical-grade stainless steel, and more easily create an optimal pocket for Implantech facial implants. Save by purchasing all three sizes.

Cat. No.	Width	Length
ELE-04	0.4 cm	7 in.
ELE-06	0.6 cm	7 in.
ELE-10	1.0 cm	7 in.



SE-100 Smoke Aspiration Tip

Simple and effective. Removes smoke, particles and body fluids. Universally adaptable to all electrocautery pencils. Clear for improved visibility. Can be cut to any length. Sterile packaged and disposable.

Cat. No.	Description
SE-100-10	Box of 10
SE-100-25	Box of 25



SILICONE CARVING BLOCKS



Implantech's silicone carving blocks are easily fashioned into patient-specific implants. Choose from multiple shapes with varying durometers:

- Contoured blocks
- Rectangular blocks

Contoured Carving Block – Style 1

Implant-grade silicone pre-formed and carvable. Made of soft-solid silicone elastomer.

Cat. No.	A	B	C	Durometer	Color
CCB1-1	11.9	5.3	1.5	Extra Soft	Clear
CCB1-2	12.6	6.1	1.6	Extra Soft	Clear
CCB1-3	13.7	6.8	1.7	Extra Soft	Clear
CCB1-4	14.0	7.8	1.9	Extra Soft	Clear
CCB1-5	16.2	9.4	2.0	Extra Soft	Clear
Individual sizes available					

Dimensions in centimeters

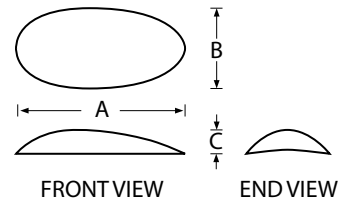

Contoured Carving Block – Style 3

Implant-grade silicone pre-formed and carvable. Made of soft-solid silicone elastomer.

Cat. No.	A	B	C	Durometer	Color
CCB3-1	11.5	4.7	2.1	Extra Soft	Clear
CCB3-2	14.1	5.0	1.8	Extra Soft	Clear
CCB3-3	17.2	6.1	2.1	Extra Soft	Clear
CCB3-4	20.3	6.5	2.1	Extra Soft	Clear
Individual sizes available					

Dimensions in centimeters

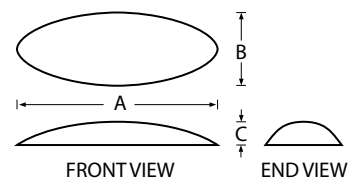

Contoured Carving Block (Ovate) – Styles 4 and 8

Implant-grade silicone pre-formed and carvable. Made of soft-solid silicone elastomer.

Cat. No.	A	B	Durometer	Color
Style 4				
CCB4-1	2.60	2.0	Extra Soft	Clear
CCB4-2	3.25	2.5	Extra Soft	Clear
CCB4-3	3.90	3.0	Extra Soft	Clear
CCB4-4	4.55	3.5	Extra Soft	Clear
CCB4-5	5.00	4.0	Extra Soft	Clear
Style 8				
CCB8-1	2.60	2.0	Extra Extra Soft	Clear
CCB8-2	3.25	2.5	Extra Extra Soft	Clear
CCB8-3	3.90	3.0	Extra Extra Soft	Clear
CCB8-4	4.55	3.5	Extra Extra Soft	Clear
CCB8-5	5.00	4.0	Extra Extra Soft	Clear
Individual sizes available				

Dimensions in centimeters

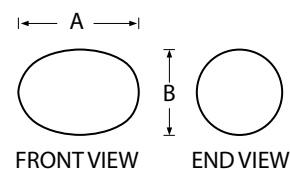

SILICONE CARVING BLOCKS



Rectangular Carving Block – Clear

Carvable into individual implant shapes. Available in three hardnesses (durometers). Supplied non-sterile (sterilization instructions included).

Cat. No.	A	B	C	Durometer	Color
BLK-10-NS	12.0	7.0	1.5	Soft	Clear
BLK-20-NS	12.0	7.0	1.5	Medium	Clear
BLK-40-NS	12.0	7.0	1.5	Firm	Clear

Dimensions in centimeters

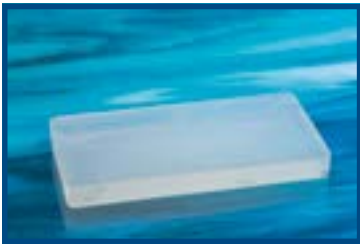
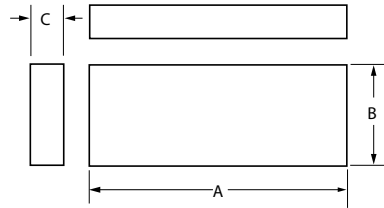

Rectangular Carving Block – Various Durometers and Colors

Carvable into individual implant shapes. Available in five hardnesses (durometers) and three colors. Supplied non-sterile (sterilization instructions included).

Cat. No.	A	B	C	Durometer	Color
BL-1.0-NS	13.6	5.8	1.0	Specify Very Soft, Soft, Medium, Firm or Very Firm	Specify Clear, Opaque or Fleshtone
BL-1.3-NS	14.8	7.6	1.3		
BL-2.0-NS	14.9	7.7	2.0		

Dimensions in centimeters

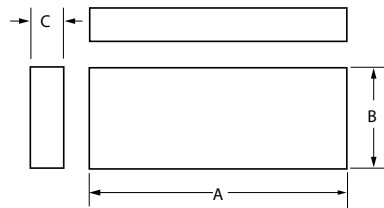

BODY-CONTOURING IMPLANTS



Implantech's high-quality body-contouring implants mean greater confidence for your patients, giving men a more muscular look and women a more curvaceous shape. Unlike shells filled with gel or saline for breast enhancement, our body-contouring implants are solid yet soft to mimic large muscles for aesthetic purposes or correcting deformities.

Symmetry, predictable volume and a seamless transition help ensure the most natural-looking patient outcomes for:

- Gluteals
- Pectorals
- Calves

GLUTEAL IMPLANTS

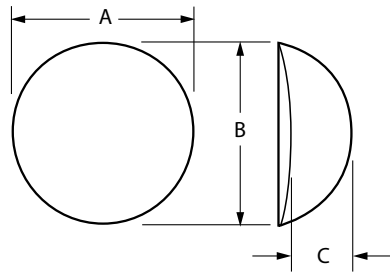

ContourFlex™ Gluteal – Round

Provides a prominent, round fullness to the buttock. Can be rolled for insertion into small surgical incisions. Hand-smoothed edges fit the patient more naturally with both subfascial and intramuscular placements. Single-packed (not in pairs).

Cat. No.	A	B	C	Volume
CCB5-K-1	10.5	10.5	2.3	125cc
CCB5-K-2	11.5	11.5	2.7	170cc
CCB5-0	12.5	12.5	3.6	276cc
CCB5-1	13.5	13.5	3.5	310cc
CCB5-2	13.5	13.5	4.1	360cc
CCB5-3	14.5	14.5	4.1	400cc
CCB5-4	13.5	13.5	5.0	460cc

Individual sizers available

Dimensions in centimeters

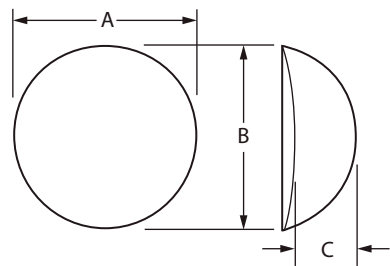
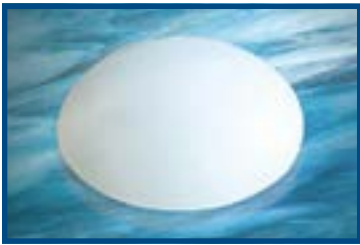

ContourFlex™ Gluteal – Round (Textured)

These gluteal implants are a selection of round implants for both intramuscular and subfascial techniques. Manufactured in extra-soft solid silicone durometer, with a textured surface. Single-packed (not in pairs).

Cat. No.	A	B	C	Volume
CCB5-T-51	10.0	10.0	2.5	180cc
CCB5-T-52	12.6	12.6	3.7	330cc
CCB5-T-53	14.9	14.9	3.9	490cc
CCB5-T-54	14.0	14.0	4.2	450cc
CCB5-T-55	13.5	13.5	4.5	420cc
CCB5-T-56	16.0	16.0	4.8	600cc

Dimensions in centimeters

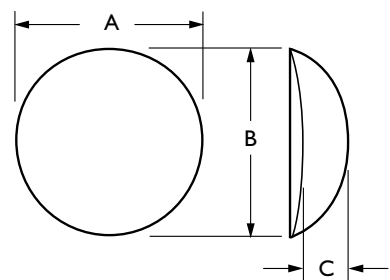

ContourFlex™ Gluteal – Round (Natural Contour)

Designed by M. Mark Mofid, MD, FACS

Provides a full yet subtle projection to provide the look of a naturally well-developed buttock. Gentler on tissues and easier to use than other profiles. Can be rolled for insertion into small surgical incisions. Tapered, smooth edges result in a more natural fit. Single-packed (not in pairs).

Cat. No.	A	B	C	Volume
CCB5-NC-1	13.0	13.0	2.8	230cc
CCB5-NC-2	13.5	13.5	3.2	275cc
CCB5-NC-3	14.0	14.0	3.6	330cc

Individual sizers available

Dimensions in centimeters

ContourFlex™ Gluteal – Anatomical

Provides a teardrop-shaped profile to the buttock. Can be rolled for insertion into small surgical incisions. Hand-smoothed edges fit the patient more naturally with both subfascial and intramuscular placements. Single-packed (not in pairs).

Cat. No.	A	B	C	Volume
CCB6-1	10.6	15.8	3.0	280cc
CCB6-2	11.5	15.7	3.3	320cc
CCB6-3	12.5	17.0	3.8	430cc
Individual sizes available				

Dimensions in centimeters

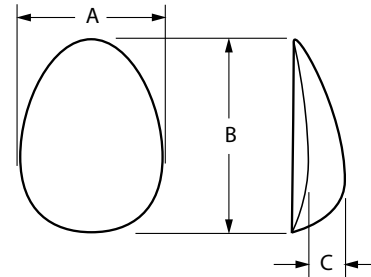

ContourFlex™ Gluteal – Anatomical (Textured)

A selection of oval implants are provided in increasing width to height ratios and volumes to adequately augment the gluteal region. Manufactured in extra-soft solid silicone durometer, with a textured surface. Single-packed (not in pairs).

Cat. No.	A	B	C	Volume
CCB6-T-71	10.5	15.0	2.5	230cc
CCB6-T-72	11.0	16.0	3.0	320cc
CCB6-T-73	12.0	16.5	3.2	370cc
CCB6-T-74	12.5	17.0	3.5	440cc

Dimensions in centimeters

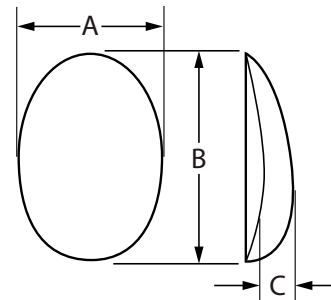

PECTORAL IMPLANTS

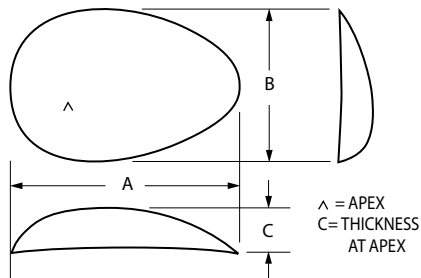

PowerFlex™ Pectoral

Provides a more oblong-shaped definition to the pectoralis muscle for cosmetic and reconstructive surgery. Specify Catalog No. for "Left (L)" or "Right (R)". Single-packed (not in pairs).

Cat. No.	A	B	C	Volume
ACPI-1L	14.2	9.0	2.1	129cc
ACPI-1R	14.2	9.0	2.1	129cc
ACPI-2L	16.5	10.0	2.1	162cc
ACPI-2R	16.5	10.0	2.1	162cc
ACPI-3L	17.0	11.4	3.0	271cc
ACPI-3R	17.0	11.4	3.0	271cc
ACPI-4L	17.6	13.4	3.2	314cc
ACPI-4R	17.6	13.4	3.2	314cc

Individual sizes available

Dimensions in centimeters

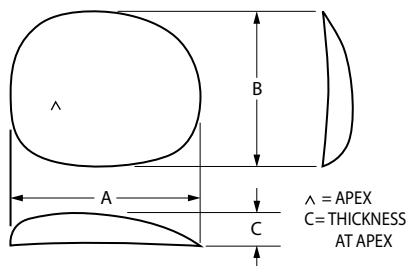

PowerFlex™ Pectoral II

Provides a more rectangular-shaped definition to the pectoralis muscle for cosmetic and reconstructive surgery. May be used vertically or horizontally. Specify Catalog No. for "Left (L)" or "Right (R)". Single-packed (not in pairs).

Cat. No.	A	B	C	Volume
ACPI2-1L	14.4	11.3	1.6	143cc
ACPI2-1R	14.4	11.3	1.6	143cc
ACPI2-2L	15.0	12.2	2.1	203cc
ACPI2-2R	15.0	12.2	2.1	203cc
ACPI2-3L	16.1	13.5	2.5	293cc
ACPI2-3R	16.1	13.5	2.5	293cc

Individual sizes available

Dimensions in centimeters

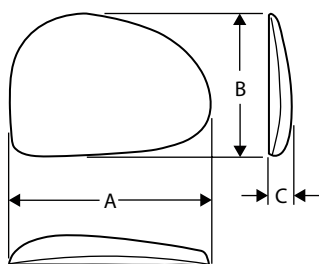

PowerFlex™ Pectoral - Aiache Style 4 (Textured)

These Aiache Style 4 implants are designed to provide greater augmentation for a larger chest area. These implants create medial definition with increased projection. Manufactured in extra-soft solid silicone durometer, with a textured surface. Specify Catalog No. for "Left (L)" or "Right (R)". Single-packed (not in pairs).

Cat. No.	A	B	C	Volume
ACPI4-T-1L	14.5	11.2	2.0	195cc
ACPI4-T-1R	14.5	11.2	2.0	195cc
ACPI4-T-2L	15.5	12.3	2.5	310cc
ACPI4-T-2R	15.5	12.3	2.5	310cc
ACPI4-T-3L	17.0	14.5	3.0	410cc
ACPI4-T-3R	17.0	14.5	3.0	410cc

Dimensions in centimeters

Novack Pectoral Implant

Used for cosmetic and reconstructive surgery to add definition to the pectoralis muscle. Made of soft solid silicone elastomer designed for long term implantation. Specify Catalog No. for "Left (L)" or "Right (R)". Single-packed (not in pairs).

Cat. No.	A	B	C	Volume
BNPI-1L	12.6	15.3	2.3	300cc
BNPI-1R	12.6	15.3	2.3	300cc
Individual sizes available				

Dimensions in centimeters

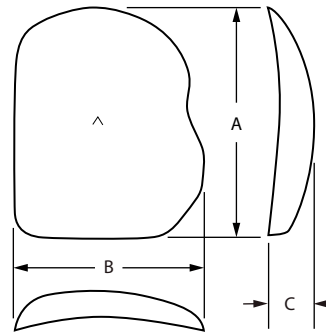

^ = APEX
C = THICKNESS AT APEX

PowerFlex™ Pectoral - Novack Style 2 (Textured)

These Novack Style 2 pectoral implants are designed to be vertically placed, which will produce more medial and upper chest wall fullness to produce a square cut definition. Manufactured in extra-soft solid silicone durometer, with a textured surface. Specify Catalog No. for "Left (L)" or "Right (R)". Single-packed (not in pairs).

Cat. No.	A	B	C	Volume
BNPI2-T-1L	15.2	12.4	2.2	345cc
BNPI2-T-1R	15.2	12.4	2.2	345cc

Dimensions in centimeters

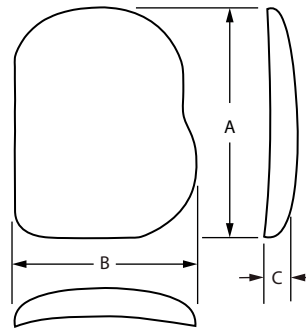

PECTORAL IMPLANTS



PowerFlex™ Pectoral - Novack Style 3 (Textured)

These Novack Style 3 implants are designed to be vertically placed, similar to the Novack Style 2. This pectoral implant has a square definition with less lateral fullness. Manufactured in extra-soft solid silicone durometer, with a textured surface. Specify Catalog No. for "Left (L)" or "Right (R)". Single-packed (not in pairs).

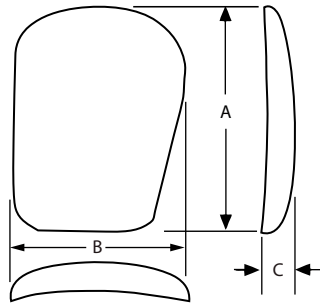

Cat. No.	A	B	C	Volume
BNPI3-T-1L	13.8	11.4	2.2	250cc
BNPI3-T-1R	13.8	11.4	2.2	250cc

Dimensions in centimeters



PowerFlex™ Plus Pectoral

Designed by J. Howell Tiller, MD

For those seeking the ultimate in pectoral augmentation. This implant provides maximal pectoral augmentation through the whole chest from just under the clavicle down to the lower edge of the pectoralis major muscle. Provides dramatic pectoral muscle augmentation and definition. Specify Catalog No. for "Left (L)" or "Right (R)". Single-packed (not in pairs).

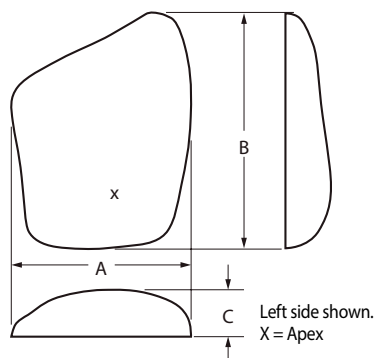

Cat. No.	A	B	C	Volume
HTPI-2L	15.0	19.6	3.9	596cc
HTPI-2R	15.0	19.6	3.9	596cc

Dimensions in centimeters

ContourFlex™ Calf

Adds mass and definition to the calf area. Provides the bulk typically sought by males and, for women, a pleasing shape proportional to their thighs. Indications also include helping to correct deformities resulting from injury or disease-related muscle deterioration. Single-packed (not in pairs).

Cat. No.	A	B	C	Volume
CCB7-1	14.9	5.0	1.5	70cc
CCB7-2	19.7	5.7	1.8	135cc
CCB7-3	23.5	6.2	1.8	170cc

Individual sizes available

Dimensions in centimeters

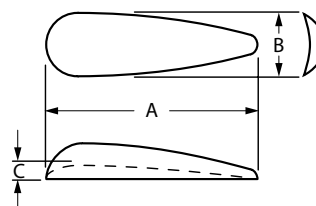

ContourFlex™ Calf - Aiache Style (Textured or Smooth)

These calf implants are designed by Dr. Adrien Aiache, a pioneer in calf augmentation. Most sizes are available in a smooth (S) or textured (T) surface. The large variety allows selecting the right width to height ratio to achieve the desired results. Manufactured in soft (slightly firmer than the durometer used in gluteal and pectoral implants) solid silicone durometer. Single-packed (not in pairs).

Cat. No.	A	B	C	Volume
CCB7-S-11	12.0	5.2	1.3	50cc
CCB7-S-21	12.7	6.0	1.5	70cc
CCB7-T-21	12.7	6.0	1.5	70cc
CCB7-S-31	14.3	6.5	1.6	95cc
CCB7-T-31	14.3	6.5	1.6	95cc
CCB7-S-41	14.5	7.5	1.7	115cc
CCB7-T-41	14.5	7.5	1.7	115cc
CCB7-S-51	16.0	9.0	2.0	185cc
CCB7-T-51	16.0	9.0	2.0	185cc
CCB7-T-61	18.6	9.4	2.2	210cc
CCB7-S-71	16.0	6.3	1.5	100cc
CCB7-T-71	16.0	6.3	1.5	100cc
CCB7-S-81	16.5	7.2	1.6	120cc
CCB7-T-81	16.5	7.2	1.6	120cc
CCB7-S-91	17.5	8.0	1.7	150cc
CCB7-T-91	17.5	8.0	1.7	150cc

Dimensions in centimeters

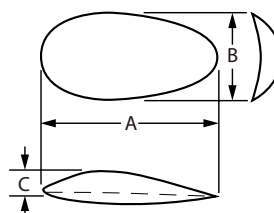

ContourFlex™ Calf - Carlsen Style (Textured)

The Carlsen Style Calf implants are a selection designed by Dr. Lloyd Carlsen, for augmentation of larger calf muscles. Manufactured in soft (slightly firmer than the durometer used in gluteal and pectoral implants) solid silicone durometer. Specify Catalog No. for "Left (L)" or "Right (R)." Single-packed (not in pairs).

Cat. No.	A	B	C	Volume
CCB7-T-C1L	18.0	7.5	1.2	135cc
CCB7-T-C1R	18.0	7.5	1.2	135cc
CCB7-T-C2L	21.5	8.5	1.6	235cc
CCB7-T-C2R	21.5	8.5	1.6	235cc
CCB7-T-C3L	25.0	10.5	2.0	335cc
CCB7-T-C3R	25.0	10.5	2.0	335cc

Dimensions in centimeters

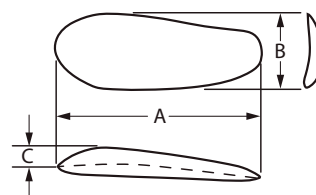

3D ACCUSCAN PATIENT-SPECIFIC[®] IMPLANTS

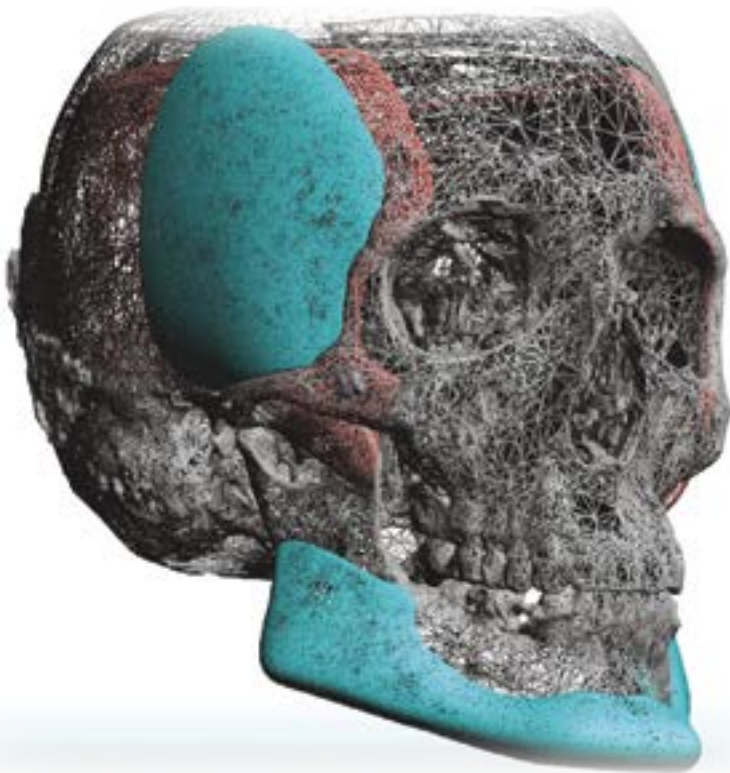

While our implant lines are quite comprehensive, stock items are occasionally insufficient for a patient's needs. As such, you can depend on Implants' patient-specific products for an ideal solution.

Offerings include:

- 3D Accuscan[®]
- Moulage Kits

3D Accuscan Patient-Specific® Implants

With 3D Accuscan®, you now have the ability to quickly and easily reconstruct most bony defects and soft tissue deficiencies. Simply supply us with the appropriate CT scan, and we will schedule a virtual planning session during which we will assist you in designing an implant specifically for your patient. Additionally, we can produce a 3D model of your patient's anatomy as a consultation or surgical aid. Contact us for additional information.

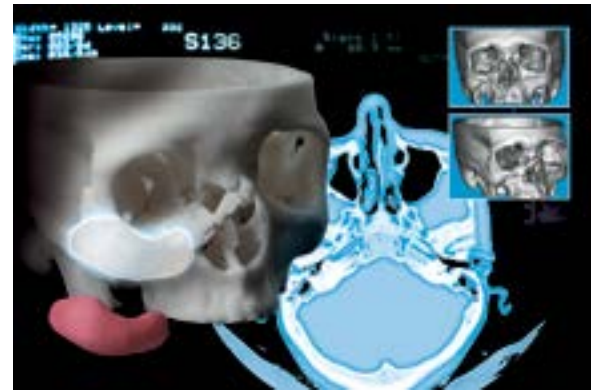

Moulage Kits

Each kit contains all items and instructions needed for you to fabricate a casting (or *moulage*) of your patient's defect. We then faithfully recreate an implant-grade silicone implant from your moulage.

Cat. No.	Material	Plaster Moulage Kit
IMK-1	Plaster	Contains enough material to fabricate a cellulose plaster moulage approximately 15cm x 15cm in area, and 2cm in thickness.



Cat. No.	Material	Silicone Moulage Kit
IMK-2	Silicone	Contains enough material to fabricate a silicone moulage approximately 14cm x 18cm in area, and 1.5cm in thickness.



SILICONE SHEETING & TUBING



Implantech is the ideal source for all your silicone sheeting and tubing needs.

Choose from a variety of products to meet your medical applications, including:

- Silicone sheeting
 - ◆ Reinforced or non-reinforced
 - ◆ Long term or short term implantable
- Silicone tubing
 - ◆ Implant Grade
 - ◆ Health Care Grade

AlliedSil™ Silicone Sheeting – Non-Reinforced, Long Term Implantable

Implantable for 30+ days. Supplied sterile. Box of 10 sheets.

Cat. No.	A	B	Thickness
23-700-05	3	2	.005
23-700-07	3	2	.007
23-700-10	3	2	.010
23-700-15	3	2	.015
23-700-20	3	2	.020
23-700-30	3	2	.030
23-700-40	3	2	.040

Dimensions in inches



Box of 10 sheets

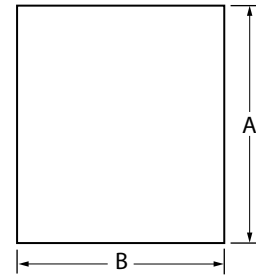

AlliedSil™ Silicone Sheeting – Non-Reinforced, Long Term Implantable

Implantable for 30+ days. Supplied sterile. Single sheet.

Cat. No.	A	B	Thickness
700-05	8	6	.005
700-07	8	6	.007
700-10	8	6	.010
700-15	8	6	.015
700-20	8	6	.020
700-30	8	6	.030
700-40	8	6	.040
700-50	8	6	.050
700-60	8	6	.060

Dimensions in inches



Single sheet

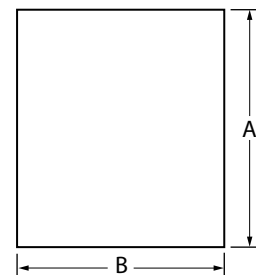

AlliedSil™ Silicone Sheeting – Non-Reinforced, Short Term Implantable

Implantable for less than 30 days. Supplied sterile. Single sheet.

Cat. No.	A	B	Thickness
600-05	8	6	.005
600-07	8	6	.007
600-10	8	6	.010
600-15	8	6	.015
600-20	8	6	.020
600-30	8	6	.030
600-40	8	6	.040
600-50	8	6	.050
600-60	8	6	.060

Dimensions in inches



Single sheet

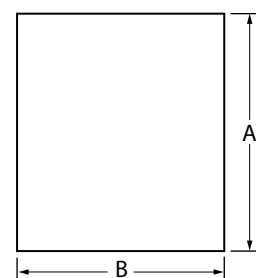

SILICONE SHEETING - REINFORCED



Box of 10 sheets

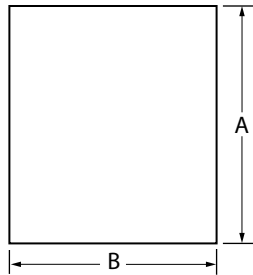

Single sheet

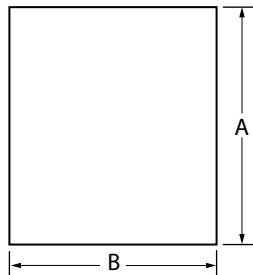

Single sheet

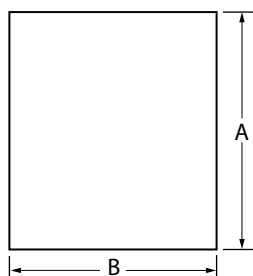

AlliedSil™ Silicone Sheeting – Reinforced, Long Term Implantable

Implantable for 30+ days. Supplied sterile. Box of 10 sheets.

Cat. No.	A	B	Thickness
23-701-07	3	2	.007
23-701-10	3	2	.010
23-701-15	3	2	.015
23-701-20	3	2	.020
23-701-30	3	2	.030
23-701-40	3	2	.040

Dimensions in inches

AlliedSil™ Silicone Sheeting – Reinforced, Long Term Implantable

Implantable for 30+ days. Supplied sterile. Single sheet.

Cat. No.	A	B	Thickness
701-07	8	6	.007
701-10	8	6	.010
701-15	8	6	.015
701-20	8	6	.020
701-30	8	6	.030
701-40	8	6	.040
701-50	8	6	.050
701-60	8	6	.060

Dimensions in inches

AlliedSil™ Silicone Sheeting – Reinforced, Short Term Implantable

Implantable for less than 30 days. Supplied sterile. Single sheet.

Cat. No.	A	B	Thickness
601-07	8	6	.007
601-10	8	6	.010
601-15	8	6	.015
601-20	8	6	.020
601-30	8	6	.030
601-40	8	6	.040
601-50	8	6	.050
601-60	8	6	.060

Dimensions in inches

AlliedSil™ Silicone Tubing – Implant Grade

Long term implantable for 30+ days. Supplied non-sterile in 50-foot lengths (sterilization instructions included).

Cat. No.	A (inches)	B (inches)	A (mm)	B (mm)
PAT-01	0.012	0.025	0.3	0.6
PAT-02	0.020	0.037	0.5	0.9
PAT-03	0.025	0.047	0.6	1.2
PAT-04	0.030	0.065	0.8	1.7
PAT-05	0.040	0.085	1.0	2.2
PAT-06	0.058	0.077	1.5	2.0
PAT-07	0.062	0.095	1.6	2.4
PAT-08	0.062	0.125	1.6	3.2
PAT-09	0.078	0.125	2.0	3.2
PAT-10	0.104	0.192	2.6	4.9
PAT-11	0.132	0.183	3.4	4.6

Dimensions as indicated

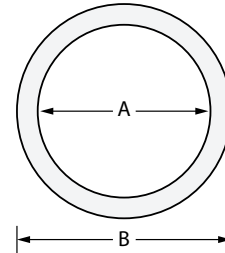

A = inside diameter
B = outside diameter

AlliedSil™ Silicone Tubing – Health Care Grade

Short term implantable for less than 30 days. Supplied non-sterile in 50-foot lengths (sterilization instructions included).

Cat. No.	A (inches)	B (inches)	A (mm)	B (mm)
HAT-12	1/8	1/4	3.2	6.4
HAT-13	3/16	5/16	4.7	7.9
HAT-14	3/16	3/8	4.7	9.5
HAT-15	1/4	3/8	6.4	9.5
HAT-16	1/4	7/16	6.4	11.1
HAT-17	1/4	1/2	6.4	12.7
HAT-18	5/16	1/2	7.9	12.7
HAT-19	3/8	1/2	9.5	12.7
HAT-20	3/8	9/16	9.5	14.3
HAT-21	3/8	5/8	9.5	15.9

Dimensions as indicated

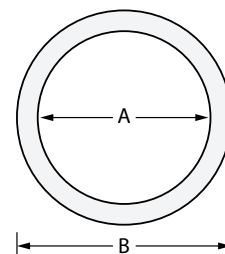

A = inside diameter
B = outside diameter

SCAR MANAGEMENT



Cimeosil®

Cimeosil® Scar and Laser Gel and gel sheeting are silicone-based products designed to improve the appearance of scars, particularly those that are raised, red and sometimes itchy and/or painful. Cimeosil is an outstanding treatment for scars occurring from accidents, heart surgery, cesarean sections, abdominoplasty and breast reconstruction.

Gelzone® Wrap

Made of stretchable, fabric-covered silicone gel, the patented Gelzone® Wrap is the only choice that combines compression healing, musculoskeletal support and scar management. The wrap stays exactly where it's put while providing ideal uniform compression. Excellent for flattening and fading keloids and hypertrophic scars. *See our selection of Gelzone wraps in our orthopaedic section on pages 46 - 47.*

Cimeosil® Scar and Laser Gel

Cimeosil® Scar and Laser Gel is topically applied to soften, flatten and fade scars (particularly those that are raised and red) as well as to manage any scarring and redness from facial laser surgery. Made only of the highest quality medical-grade silicone, Cimeosil Scar and Laser Gel is safe for both adults and children when used as directed. May be worn over sunscreen and under makeup. Choose from 5 gram and 14 gram tubes.



Cat. No.	Description
CSG-05	Cimeosil Scar and Laser Gel-5 gram tube
CSG-14	Cimeosil Scar and Laser Gel-14 gram tube

Cimeosil® Scar and Laser Gel 12-pack

Save by choosing an economical 12-pack carton of Cimeosil® Scar and Laser Gel with either 5 gram or 14 gram tubes.

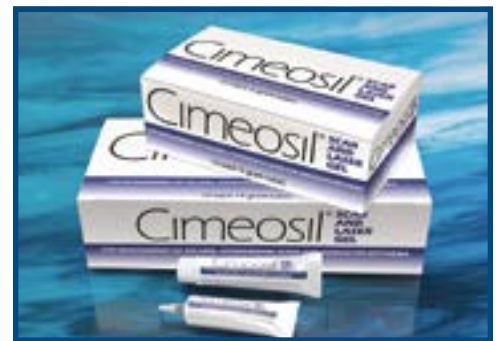

Cat. No.	Description
CSG-05-12PK	Cimeosil Scar and Laser Gel-5 gram tube
CSG-14-12PK	Cimeosil Scar and Laser Gel-14 gram tube

CIMEOSIL® GEL SHEETING

Recommended for older, deeper, more persistent scars. Gel sheeting is self-adhering, reusable and washable. All gel sheeting can be cut down to fit specific scar areas. A drying mat is included with each sheet.

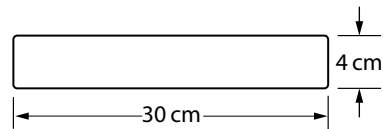

Gel Sheeting – Long Strip

To reduce large straight scarring resulting from cesarean sections, appendectomies, cardiac surgery, plastic surgery of the thighs and waist and non-surgical trauma. Sold individually, save by purchasing 6 units or more.

Cat. No.	Description
GS-LS	Long Strip

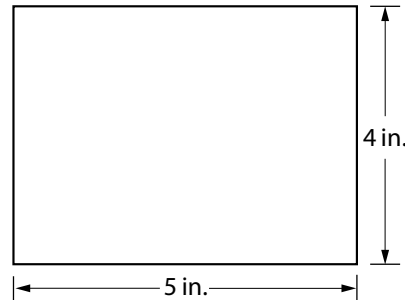

Gel Sheeting – 4" x 5"

Multi-purpose - can be cut down to fit specific scar areas. Sold individually, save by purchasing 6 units or more.

Cat. No.	Description
GS-04-05	Sheet

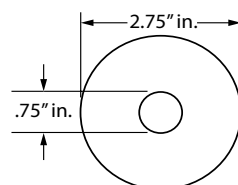
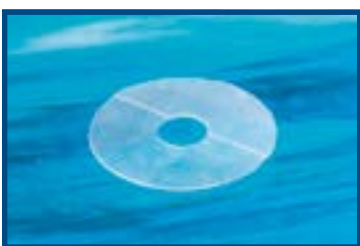

Gel Sheeting – Areola Circle

To reduce scarring resulting from areola reconstruction or breast augmentation surgery. Sold individually, save by purchasing 6 units or more.

Cat. No.	Description
GS-AC	Areola Circle

Gel Sheeting – Vertical Mastopexy ‘Lollipop’

To reduce scarring from areola reconstruction, breast reduction or reconstructive surgery. Sold individually, save by purchasing 6 units or more.

Cat. No.	Description
GS-VM	Vertical Mastopexy

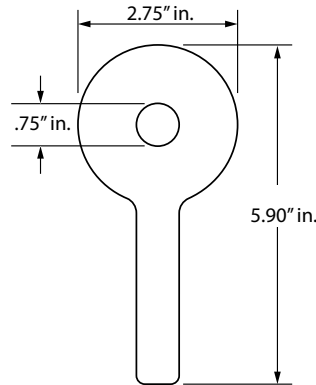

Gel Sheeting – Breast Reduction ‘Anchor’

To reduce scarring of typical incisions that result from breast reduction or reconstructive surgery. Sold individually, save by purchasing 6 units or more.

Cat. No.	Description
GS-BR	Breast Reduction

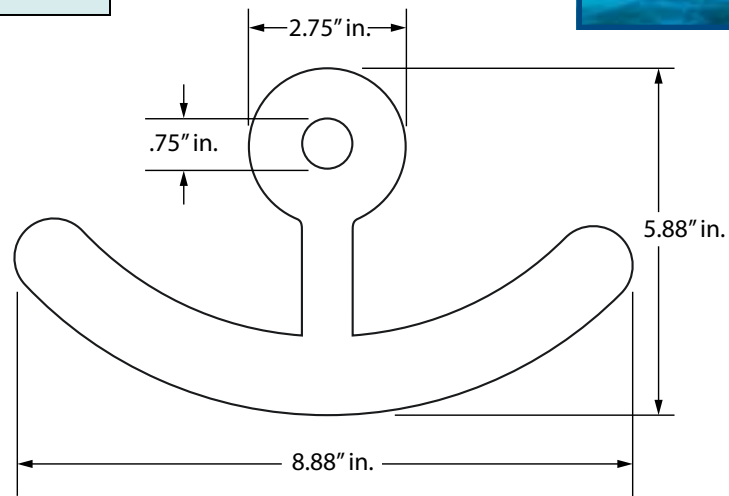

Cimeosil® Drying Mat

Each Cimeosil® Gel Sheeting product comes with a convenient drying mat. With its aerated grid, this plastic mat provides an ideal drying surface for your just-washed gel sheeting.



ORTHOPAEDIC PRODUCTS



WeL® Anti-Clog Suction Tubes

Suction Where You Want It...

Suctioning body fluids and particles is critical to any procedure. Too much suction can cause tissue damage, while too little suction can reduce visibility at the surgical site.

..When You Need It

The WeL® family of disposable, malleable suction tubes consists of full-flow, anti-clog tips for maximum on-the-spot aspiration, with the Positive Control On/Off Valve giving you complete control of the suction force.

Gelzone® Suspension Sleeve

Uniquely combines ease of use and comfortable, secure suspension.

Gelzone® Wrap

Made of stretchable, fabric-covered silicone gel, the patented Gelzone® Wrap is the only choice that combines compression healing, musculoskeletal support and scar management. The wrap stays exactly where it's put while providing ideal uniform compression. Excellent for flattening and fading keloids and hypertrophic scars.

WeL® Orthopaedic Suction Tube

The Orthopaedic Suction Tube ensures unparalleled aspiration for bone chips, body fluids and tissue. The constant 1/4-inch internal diameter provides full flow for even the most demanding surgical procedures.

Cat. No.	Description	Quantity
3706-ST	Individually Packaged & Sterile	50
3706-B	Non-Sterile in bulk	100

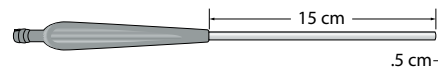

WeL® Bullet Nosed Tip

The Bullet-nosed five-hole tip maximizes aspiration. If one of the holes becomes clogged with tissue or debris, the other holes will compensate providing a true anti-clog tip. Its Positive Control On/Off Valve gives you total control of the suction force.

Cat. No.	Description	Quantity
5091-ST	Individually Packaged & Sterile	50
5091-B	Non-Sterile in bulk	100

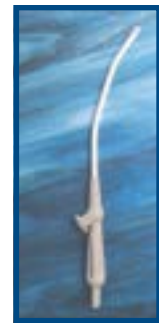
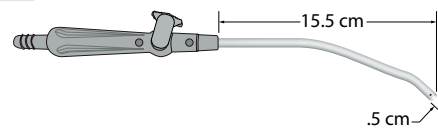

WeL® Retractor-Nosed Tip

The Retractor-nosed five-hole tip aids in moving tissue aside for improved visibility. Like the 5091, the Retractor is also anti-clog and allows complete control of the suction force with the On/Off Valve.

Cat. No.	Description	Quantity
5092-ST	Individually Packaged & Sterile	50
5092-B	Non-Sterile in bulk	100

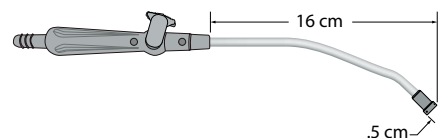

Gelzone® Suspension Sleeve

Ideal for procedures requiring a stable, upright patient arm, the Gelzone® suspension sleeve features silicone gel sheeting covered by fabric. The silicone provides a non-slip surface against skin, while the fabric enables secure and comfortable closure around the patient's arm with Velcro tabs. Using a Velcro™ ring tab secured to the end of the sleeve, the arm is suspended at the desired position by a traction device. Choose the Gelzone® Suspension Sleeve for all elevated-arm procedures.



Cat. No.	Description	Size
SLV-634	Sterile Suspension Sleeve	6" x 34"

Dimensions in inches

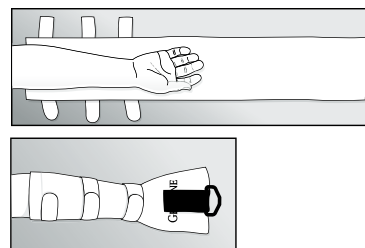

GELZONE® WRAP

Benefits include non-slip compression for healing (after wound closure), complete silicone gel contact on closed wounds for scar management in difficult areas, general joint for muscle support and cold-wrap therapy. Velcro closure (extra tabs provided). All Gelzone® Wraps can be cut to size using scissors.



Gelzone® 1" x 12" Wrap

Color: White

Suggested Uses:

Wrist Support; Carpal Tunnel Support; General Joint or Muscle Support; Cold Wrap Therapy; Compression for Healing and Scar Management.

Cat. No.	Description
WRAP-112	1" x 12" Wrap



Gelzone® 2" x 16" Wrap

Color: White

Suggested Uses:

Kneecap Tendonitis; Carpal Tunnel; Tennis Elbow; General Joint or Muscle Support; Cold Wrap Therapy; Compression for Healing and Scar Management.

Cat. No.	Description
WRAP-216	2" x 16" Wrap



Gelzone® 4" x 12" Wrap

Color: Blue

Suggested Uses:

Kneecap Tendonitis; Tennis Elbow; General Joint or Muscle Support; Cold Wrap Therapy; Compression for Healing; Osteoarthritis and Scar Management.

Cat. No.	Description
WRAP-412	4" x 12" Wrap



Gelzone® 4" x 24" Wrap

Color: Blue

Suggested Uses:

Kneecap Tendonitis; Tennis Elbow; General Joint or Muscle Support; Cold Wrap Therapy; Compression for Healing; Osteoarthritis and Scar Management.

Cat. No.	Description
WRAP-424	4" x 24" Wrap

Gelzone® 4" x 40" Wrap

Color: Blue

Suggested Uses:

Arm Support & Scar Management (After Brachioplasty); Tennis Elbow; General Joint or Muscle Support; Cold Wrap Therapy; Compression for Healing; Hamstring or Hip Pointer; Osteoarthritis and Scar Management.

Cat. No.	Description
WRAP-440	4" x 40" Wrap



Gelzone® 6" x 48" Wrap

Color: White

Suggested Uses:

Abdominal Support & Scar Management (After Liposuction); Abdominal Support & Scar Management (After C-Section); Abdominal Support & Scar Management (After Tummy Tuck); Arm Support & Scar Management (After Brachioplasty); General Joint or Muscle Support; Cold Wrap Therapy; Compression for Healing; Hamstring or Hip Pointer; Rib or Thorax Wrap; Osteoarthritis and Scar Management.

Cat. No.	Description
WRAP-648	6" x 48" Wrap



Gelzone® 10" x 48" Wrap

Color: White

Suggested Uses:

Abdominal Support & Scar Management (After Liposuction); Abdominal Support & Scar Management (After C-Section); Abdominal Support & Scar Management (After Tummy Tuck); Arm Support & Scar Management (After Brachioplasty); General Joint or Muscle Support; Cold Wrap Therapy; Compression for Healing; Hamstring or Hip Pointer; Rib or Thorax Wrap; Osteoarthritis and Scar Management.

Cat. No.	Description
WRAP-1048	10" x 48" Wrap



Gelzone® Pressure Pillow

Use this small silicone pillow under your Gelzone® wrap to localize pressure on the muscle. Focused pressure, concentrated on the muscle, provides more support, more pain relief, and less constriction. Use the Pressure Pillow on your wrist, elbow, knee – wherever more pressure feels better!

Cat. No.	Description
PP-1530	Pressure Pillow



ORDERING INFORMATION

Thank you for your interest in Implantech's superior aesthetic products. We're pleased to offer various ways in which to order:

Customers within the USA:

Go on line at www.implantech.com

- New customers: Access "Physician Registration" to create an account, then login
- Existing accounts: Access "Physician Login"
- Shop, order and pay with Mastercard, Visa or American Express

Call or email our friendly and knowledgeable customer service specialists:

800-733-0833

customerservice@implantech.com

Contact your area's Implantech sales representative – to obtain their information, please contact customer service.

International Customers:

Orders must be placed through an Implantech distributor in your country. To find a distributor, please access our "Distributor Locator" page at

www.implantech.com/distributor

Call or email our international customer service department:

805-339-9415

international@implantech.com

Product Returns:

All returns and exchanges must be pre-authorized by calling Implantech for a 'Return Goods Authorization' (RGA) number.

Patient-specific products and opened implant packages are non-returnable, and freight charges are ineligible for credit or refunds.

For our complete return/exchange policy, please refer to

www.implantech.com/return-policy.



Implantech[®]
Superior Patient Aesthetics

6025 Nicolle Street | Ventura, CA 93003
800.733.0833 | Fax 805.339.9414 | implantech.com

Implantech[®]

Superior Patient Aesthetics

6025 Nicolle Street • Ventura, CA 93003

800.733.0833 | implantech.com